

GLOBE CEILING 12 UP

SE22-0

SE22-1



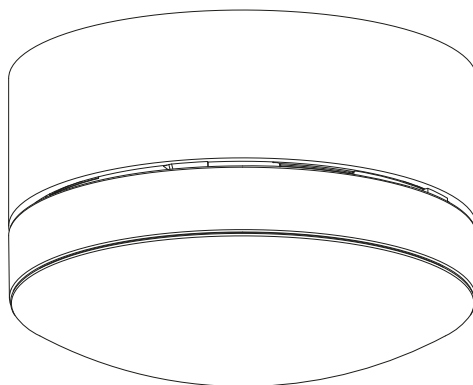

SE22-2

SE22-3



GRAU

Lieferumfang • Scope of delivery

Lieferumfang/ scope of delivery		Anzahl / quantity
Leuchte luminaire		1
Deckenblech ceiling panel		1
Abdeckung cover		1
Treiber driver		1
Schrauben & Dübel screws & dowels		3

Montageanleitung • Assembly instructions • Notice de montage

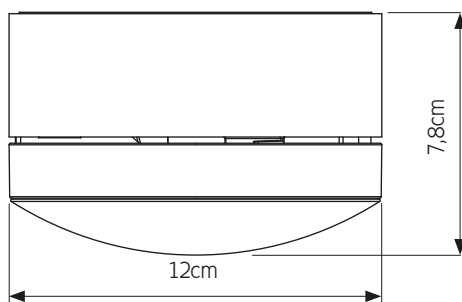

01 ①

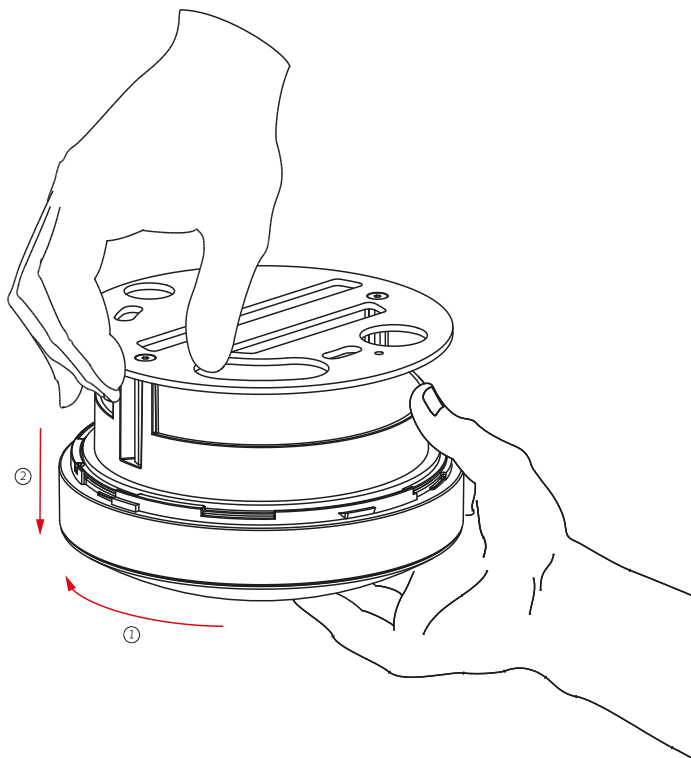

i ①

02 ② ③

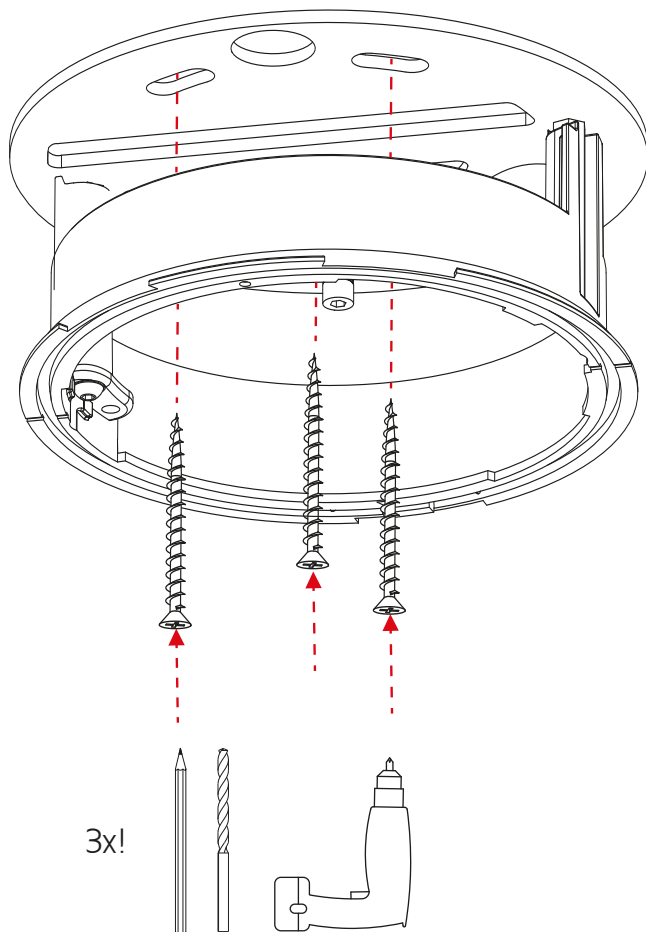

i ② ③

03 4 5 9

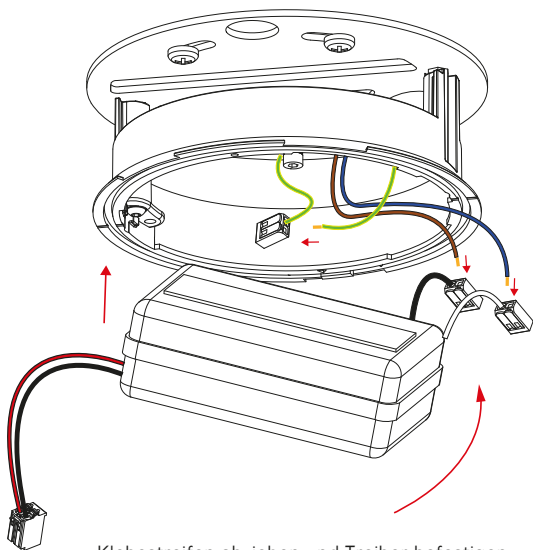
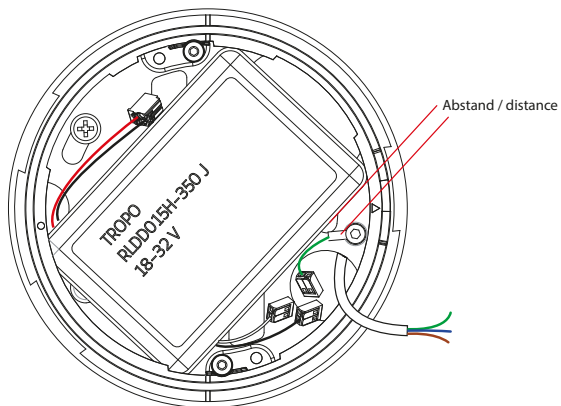

Klebestreifen abziehen und Treiber befestigen

	Kennfarbe	code colour
L =	braun (schwarz)	brown (black)
N =	blau (weiß)	blue (white)
⊕ =	grün/gelb	green/yellow

i 4 5 9

04



Bitte beachten Sie, dass vor Verbindung der Kabel, die Stromversorgung getrennt ist, da sonst die LED Schaden nimmt.

Please make sure that the power supply is disconnected before connecting the cable, otherwise the LED will be damaged.

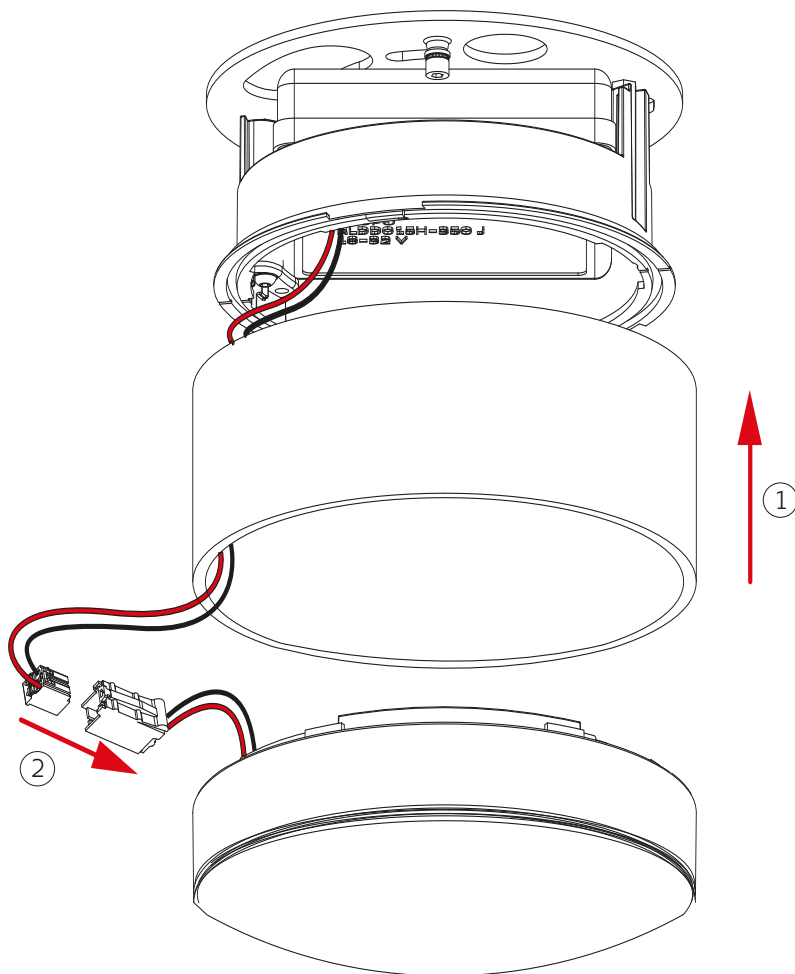

05 7 8

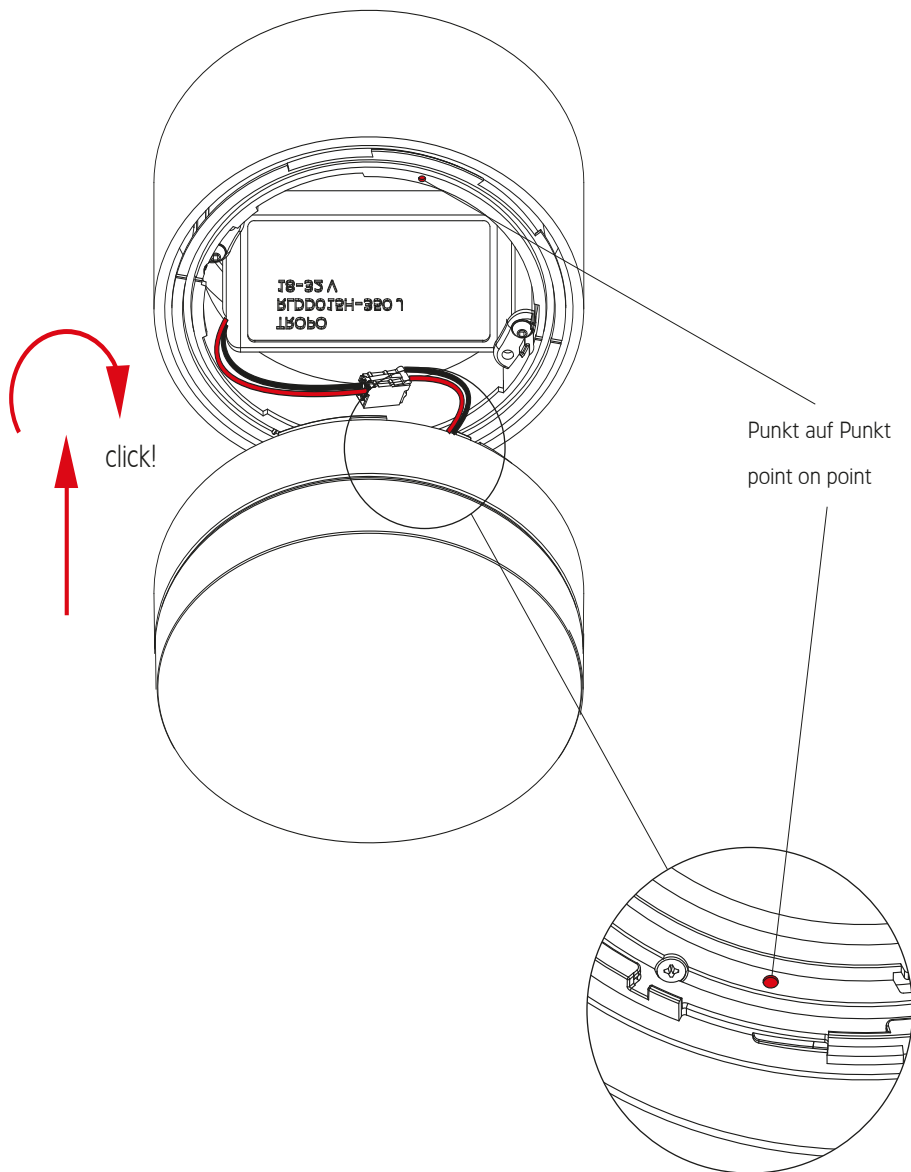

i 7 8



DEUTSCH

- ① Die Ware muss vor Montage auf optische Fehler bzw. Kratzer überprüft werden. Mit der Montage erlischt der Reklamationsanspruch auf optische Mängel der Ware.
- ② Die Auswahl der richtigen Befestigungsmittel obliegt dem Installateur.
- ③ Bitte lassen Sie die Montage von einem Elektrofachbetrieb durchführen.
- ④ Bitte benutzen Sie zum Dimmen der Leuchten nur Phasen-Drehdimmer mit Druck-Ausschalter und einem Leistungsbereich beginnend ab $\leq 20W$.
- ⑤ Aus technischen Gründen beginnt der Dimmbereich erst bei 30% und nutzt nicht den gesamten Drehwinkel des Dimmers.
- ⑥ Abweichungen bei der Helligkeit und dem Weißton der verwendeten LEDs sind herstellungsbedingt und kein Grund für eine Beanstandung.
- ⑦ Bitte die Leuchte ausschließlich mit einem trockenen Tuch reinigen. Wir empfehlen Microfasertücher für empfindliche Oberflächen. Das Reinigen muss in abgekühltem Zustand erfolgen.
- ⑧ **Oberflächenschutz:**
Alle polierten, lackierten oder galvanisch veredelten Oberflächen sind vor Belastungen jeglicher Art zu schützen – insbesondere alle Kupferteile, welche nur mit einem unsichtbaren Anlaufschutz versehen sind.

GLOBE CEILING 12 UP	
	Schutzklasse 1
	Dieses Produkt enthält eine Lichtquelle der Energieeffizienzklasse F. Diese kann nur vom Hersteller ausgetauscht werden.
	PRI 220 - 240 V / 50/60 Hz / SEC 350mA / 12W LED
	73/23/EWG 89/336/EWG





GARANTIE:

Sie haben ein hochwertiges Produkt erworben, welches mit Sorgfalt produziert und verpackt worden ist. Sollten Sie dennoch einmal Grund zur Beanstandung haben, wenden Sie sich bitte ausschließlich an Ihren Händler. Geben Sie bitte die auf der letzten Seite genannte Endkontrollnummer bei Ihrer Reklamation an. Ihre Reklamation wird bei uns im Hause umgehend bearbeitet. Bitte haben Sie Verständnis, dass eine Garantie unsererseits nur bei sachgemäßer Montage übernommen werden kann - wir empfehlen daher Fachbetriebe.



ENGLISH

- ① The products must be checked for visual defects, and/or scratches, prior to assembly. Once the product has been assembled, the right for a customer to make a complaint due to visual defects expires.
- ② It is the installer's responsibility to choose the correct fixing method.
- ③ Please have a qualified electrical specialist carry out the installation.
- ④ To dim this luminaire, please only use a reverse phase-cutting rotary dimmer. The rotary dimmer must have a built in on/off switch and a power range starting from $\leq 20W$.
- ⑤ For technical reasons, the dimmer range starts at 30% and does not use the entire rotation angle of the dimmer.
- ⑥ Differences in brightness and white tone of the LED's are conditional of manufacturing and are no reason for a complaint.
- ⑦ Please clean the lamp with a dry cloth. We recommend microfibre cloths for sensitive surfaces. Only clean the lamp after it has cooled down.
- ⑧ Surface protection:
All polished, lacquered or galvanised surfaces have to be protected against all types of stresses – especially all copper parts, as they are only provided with an invisible protection against tarnishing.

GLOBE CEILING 12 UP	
	Protection class 1
	This product contains a light source of energy efficiency class F. The LEDs can be replaced by the producer only.
	PRI 220 - 240 V / 50/60 Hz / SEC 350mA / 12W LED
	73/23/EWG 89/336/EWG





GUARANTEE:

You have purchased a high-quality product that was produced and packaged with the utmost care. Should you nevertheless have grounds for complaint, please contact your retailer quoting the final inspection number as stated on the last page of this document. We will deal with your complaint immediately. This warranty applies only to products that have been fitted appropriately – we therefore recommend fitting by qualified personnel.



FRANÇAIS

- ① Avant tout montage, veuillez vérifier que le luminaire ne présente aucun défaut apparent (p.ex. rayures). Aucune réclamation ne peut être acceptée après montage.
- ② Le choix des moyens de fixations appropriés incombe à l'installateur.
- ③ Merci de contacter un spécialiste agréé en électricité pour le montage.
- ④ Veuillez utiliser pour la variation de la luminosité uniquement un variateur rotatif à phases avec arrêt par pression et une performance commençant à $\leq 20W$.
- ⑤ Pour raisons techniques, la variation lumineuse commence à 30% et n'utilise pas tout le rayon d'action du variateur.
- ⑥ Des différences de clarté et de couleur des blancs des LED sont liées à la production et ne donnent pas lieu à réclamation.
- ⑦ Veuillez nettoyer le luminaire uniquement avec un tissu sec. Nous conseillons des tissus micro pour surfaces sensibles. Le nettoyage doit s'effectuer lorsque le luminaire est froid.
- ⑧ Protection de la surface :
Toutes les surfaces polies, laquées ou galvanisées doivent être protégées des moindres sollicitations mécaniques ou chimiques, en particulier les pièces en cuivre, étant uniquement protégées par un traitement non - visible antioxydant.

GLOBE CEILING 12 UP	
	Classe de protection 1
	Ce produit contient une source lumineuse de classe d'efficacité énergétique F. Les LED intégrés dans le luminaire ne peuvent être remplacés que par le fabricant.
	PRI 220 - 240 V / 50/60 Hz / SEC 350mA / 12W LED
	73/23/EWG 89/336/EWG





GARANTIE:

Vous venez de faire l'acquisition d'un produit de haute qualité, fabriqué et emballé avec le plus grand soin. Si, malgré le soin apporté, vous êtes amené à rencontrer un problème, merci de contacter exclusivement votre revendeur en indiquant le numéro de contrôle qui se trouve en dernière page. Notre société donnera suite sans tarder à votre réclamation. Vous comprenez aisément que nous ne pouvons assurer de garantie que dans le cas où le montage du matériel a été effectué correctement - par conséquent, nous vous recommandons de vous adresser à un spécialiste.



ITALIANO

- ① Il prodotto deve essere controllato prima dell'assemblaggio. Difetti visuali/graffi, se riscontrati, devono essere segnalati prima di installare la lampada, altrimenti il cliente non avrà più diritto al reclamo.
- ② It is the installer's responsibility to choose the correct fixing method.
- ③ Per favore fate eseguire l'installazione da un elettricista.
- ④ Per favore utilizzare solo regolatori a taglio di fase con rotella con interruttore a pressione, potenza a partire da 20W.
- ⑤ Per cause tecniche la regolazione inizia da 30% e non utilizza l'intera rotazione dell'apparecchio.
- ⑥ Differenze in luminosità e nella tonalità bianca dei LED utilizzati sono dovute alla fabbricazione e non costituiscono motivo di reclamo.
- ⑦ Per favore pulire la lampada esclusivamente con un panno asciutto. Si consiglia di utilizzare tessuti in microfibra. Le lampade devono essere fredde durante la pulizia.
- ⑧ Protezione delle superfici :
Tutte le superfici trattate con lucidatura, lacca o in bagni galvanici, sono da proteggersi da qualsiasi tipo di sollecito, in particolare quelle in rame, che hanno solo un sottile film contro la colorazione nel tempo.

GLOBE CEILING 12 UP	
	Classe di sicurezza 1
	Questo prodotto contiene una sorgente luminosa di classe di efficienza energetica F. I LEDs possono essere cambiati esclusivamente dal produttore.
	PRI 220 - 240 V / 50/60 Hz / SEC 350mA / 12W LED
	73/23/EWG 89/336/EWG

GARANZIA:

Avete deciso di acquistare un prodotto d'alto valore, prodotto ed imballato con accuratezza. Se ci fossero ragioni per un reclamo, vi preghiamo di rivolgervi esclusivamente al vostro rivenditore di fiducia. Per favore indicate per chiarezza il numero di controllo stampato sull'ultima pagina. Il vostro reclamo sarà elaborato presso di noi. Considerate che da parte nostra possiamo assumere la garanzia del prodotto soltanto nel caso in cui il montaggio avvenga a regola d'arte: consigliamo dunque di rivolgersi ad aziende d'installazione specializzate.

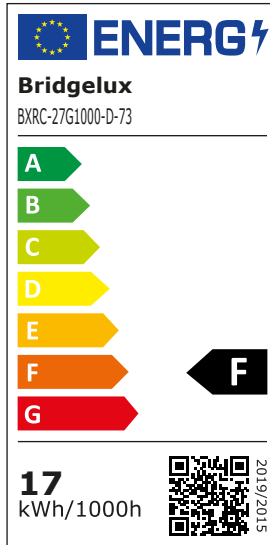

Endkontrollnummer	2 Jahre Garantie 5 Jahre Garantie auf die LED
Final inspection number	2 years guarantee 5 years guarantee of LED
Numéro de contrôle final	2 ans de garantie 5 ans de garantie sur les LED
Numero di controllo finale	2 anni di garanzia 5 anni di garanzia per i LED

