

Occhio

Sento head einseitig

Montageanleitung



Montage head (inserts)

head



Farbfilter
(optional)



Diffusorglas



Version B



soft edge Glas,
satiniertes Glas oder
Farbfilter (optional)



Linse



Version C

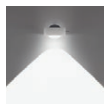

spot Linse



soft edge Glas



Linse



Version S 40

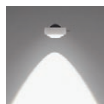

spot Linse



Fresnel Linse



Linse



Version S 30



Montage head (inserts)

Farbfilter / Diffusorglas

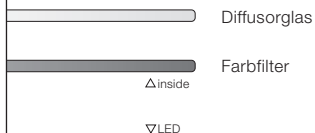

Farbfilter / Linse

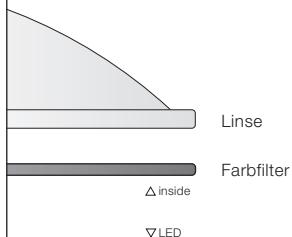

soft edge Glas / Linse

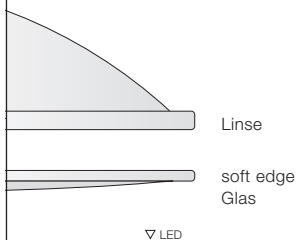

Fresnel Linse / Linse

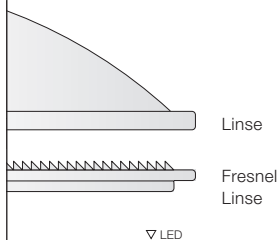

Achtung: Die Oberfläche des Strahlers kann nach längerer Betriebsdauer heiß sein! Vor allen Arbeiten am Strahler diesen immer ausschalten und mindestens 30 Minuten abkühlen lassen.



Achtung: Nicht direkt in die brennende LED blicken! Dies kann zu Nachbildern und bei längerer Dauer zu Schädigungen der Augen führen! LED nicht berühren. Sie kann dadurch beschädigt werden!

Montage head (inserts)

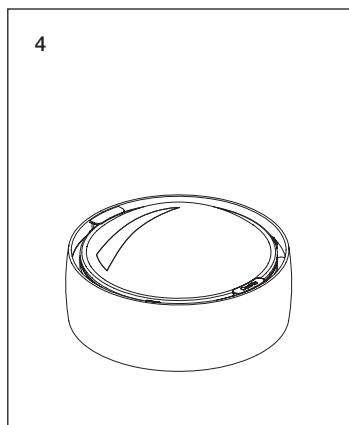
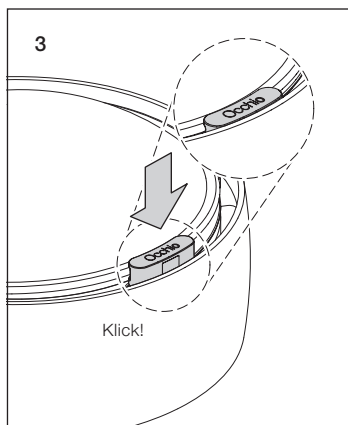
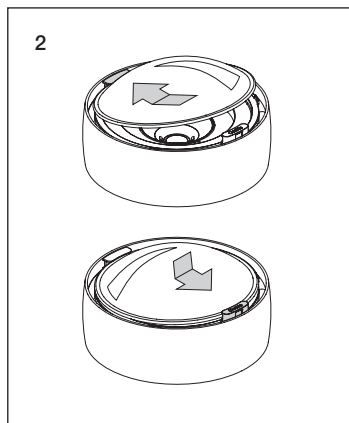
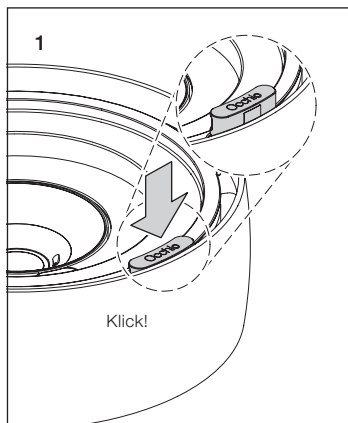

Montage head + body

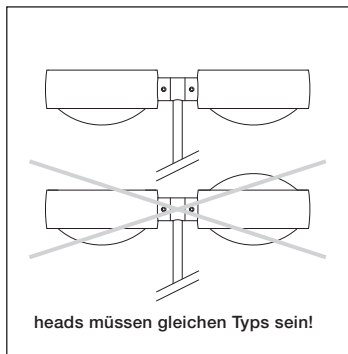
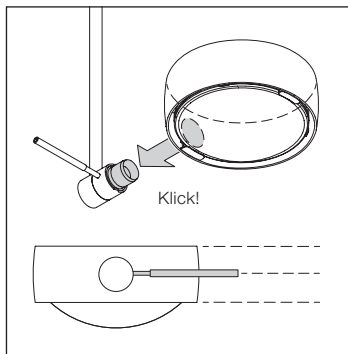

head abnehmen

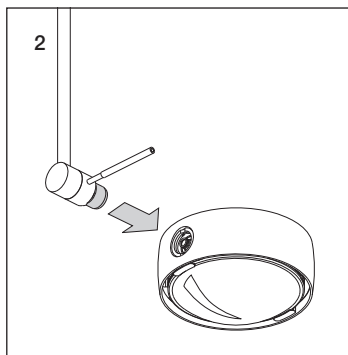
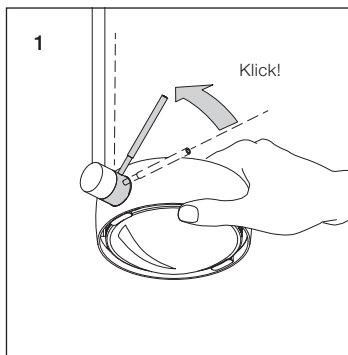

Montage spot Linse (optional)

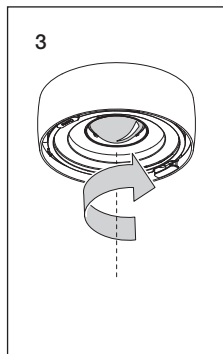
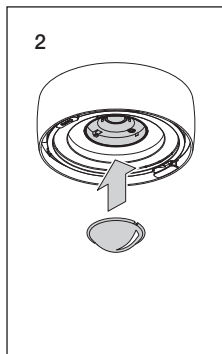
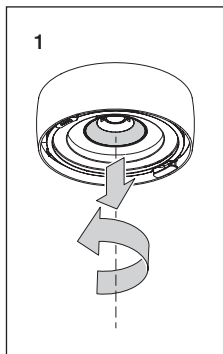

spot Linse entnehmen

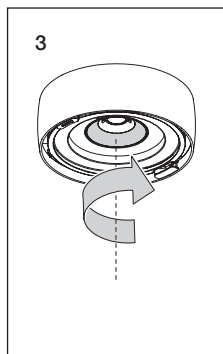
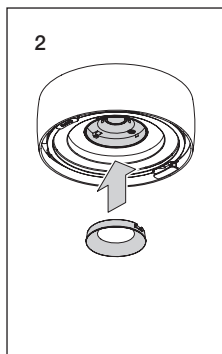
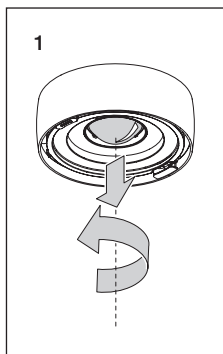

Fixierring montieren (optional / Zubehör)

1

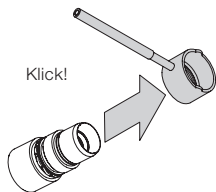

2

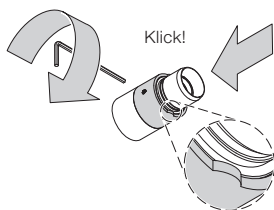

Karborgriff montieren

1

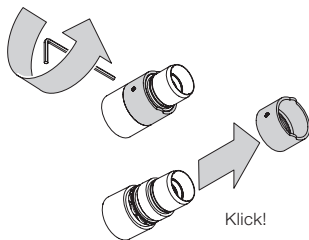

2

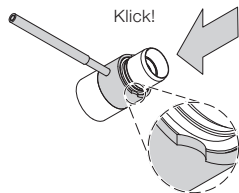

Occhio

Sento head einseitig

Bedienungsanleitung





touchless control



head auf DIM einstellen

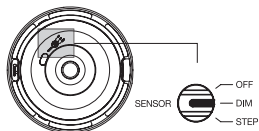

- OFF** Extern schalten und dimmen
- DIM** »touchless control«
Berührungslose Steuerung
- STEP** »preset«
Voreinstellung Helligkeit
Extern schalten und dimmen

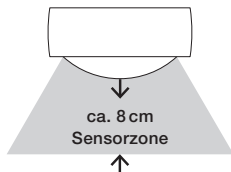

Bedienung »touchless control«

ON/OFF

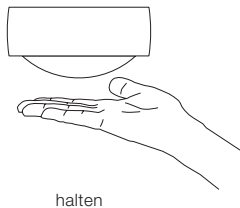
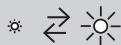
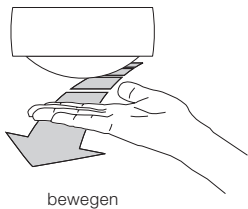



brightness
preset



head auf STEP einstellen

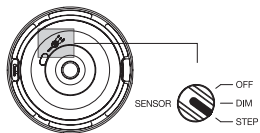

- OFF** Extern schalten und dimmen
DIM »touchless control«
Berührungslose Steuerung
STEP »preset«
Voreinstellung Helligkeit
Extern schalten und dimmen

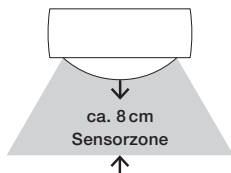

Helligkeit einstellen und speichern

1

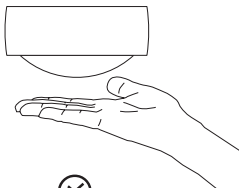

10 Sek. halten

Leuchte wird entsperrt und blinkt zur Bestätigung

2

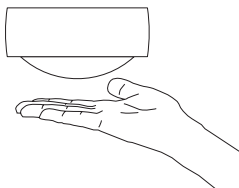

halten

Leuchte in 5 Stufen auf-/abdimmen

3

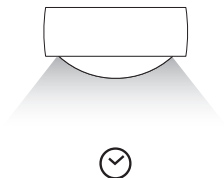

5 Min. warten oder
netzseitig aus-/einschalten

Einstellung ist nun gespeichert

4

ON / OFF – DIM







Schalter /
Dimmer*

Schalten und Dimmen

Leuchte bleibt in der
gespeicherten Einstellung

Technische Daten

Technische Daten head

Artikelbezeichnung	Occhio Sento head einseitig
Abmessungen	ø 123 mm, H 42 mm (ohne Linse)
Schutzklasse	3
Betriebsspannung	48V DC, min. 22W für 18W head, min. 30W für 26W head
Vorschaltgerät	extern
Dimmung	mittels head / geeignetem Vorschaltgerät
Material Leuchte	Aluminium, Stahl verchromt, lackiert oder eloxiert, Kunststoff
Material inserts	Glas, optischer Kunststoff
LED Leistung	18W / 26W je nach head
Zulässige Betriebsbedingung	max. 30°C (nur im Innenbereich betreiben)
Prüfzeichen	IP 20     

Technische Daten LED

Leuchtmittel	Occhio LED
Ausführung	LED-Chip (wechselbar)
Lebensdauer	> 50.000 Std.
Energieeffizienzklasse – EEK	A++ / A+

Entsorgung

Bei örtlicher Entsorgungsstelle entsorgen. Das Vorschaltgerät und der head sind recyclebar; RoHS-konform. **Nicht in den Hausmüll geben!**

