

BULBULLIA

design Francisco Gomez Paz

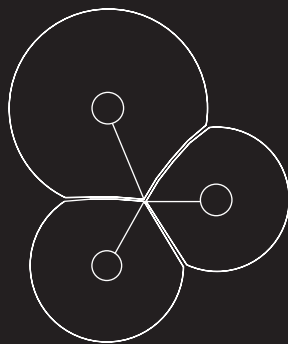
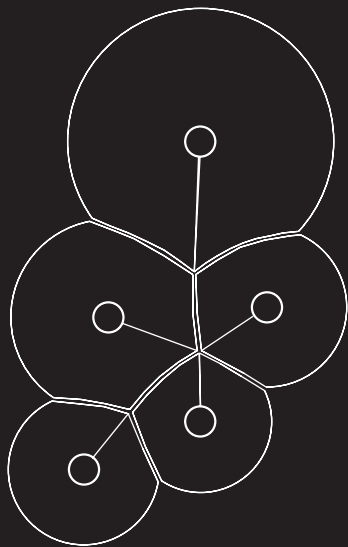

**LUCE
PLAN**

D95



D95

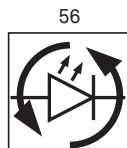
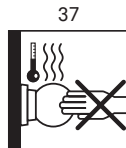
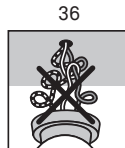
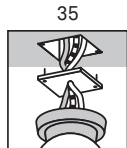
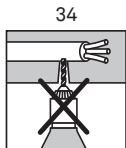
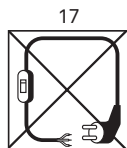
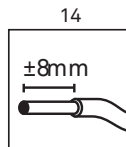
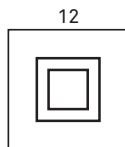
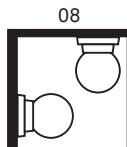
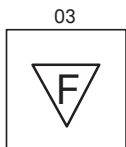
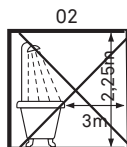
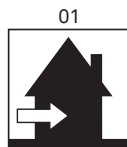

* D95A5 + D95A3: Wall mounted Trailing Edge dimmers – see datasheet www.luceplan.com

D95A5 - D95A5D

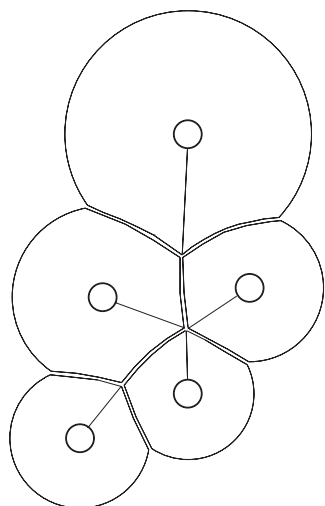

37 cm

14.5"

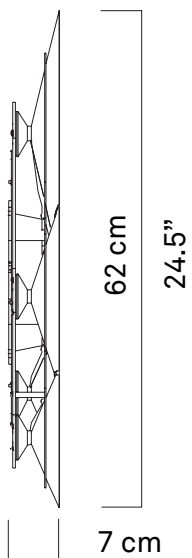

62 cm

24.5"

7 cm

2.7"

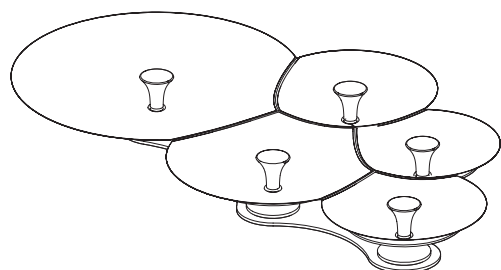

x1

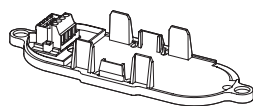

x1



x5

kg 1,1 kg

lb 2,4 lb

D95A3 - D95A3D



a



b

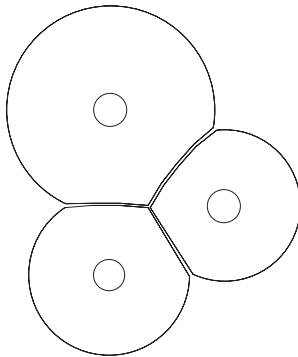

31 cm

12.2"

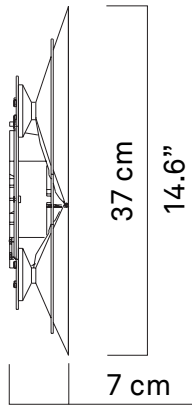

37 cm

14.6"

7 cm

2.7"

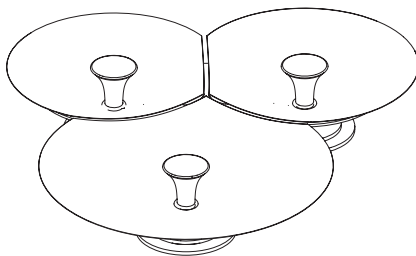

x1

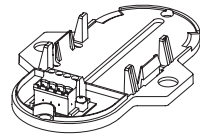

x1



x3

kg 0,7 kg

lb 1,5 lb

1 1.1 D95A5 - D95A5D

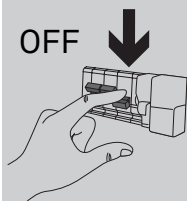
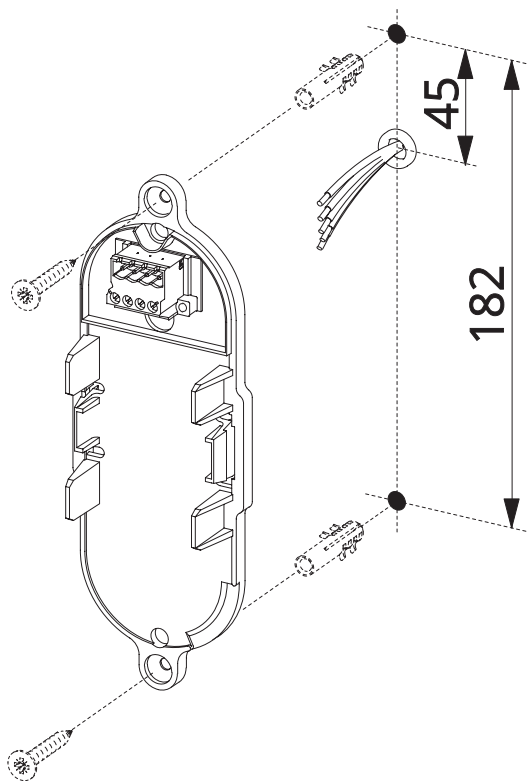
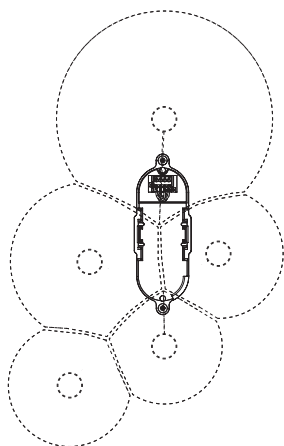

D95A3 - D95A3D

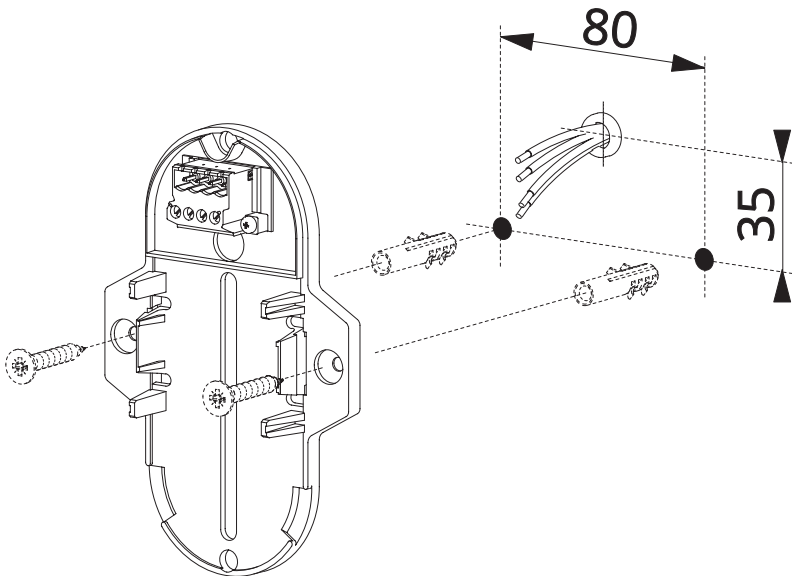
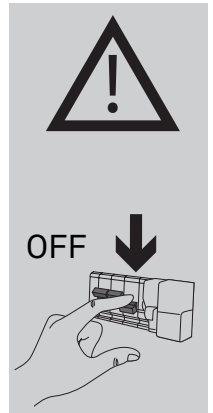
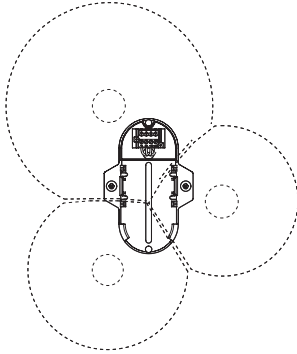

1.2 D95A5 - D95A3

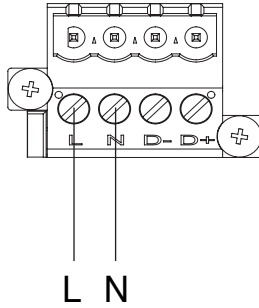
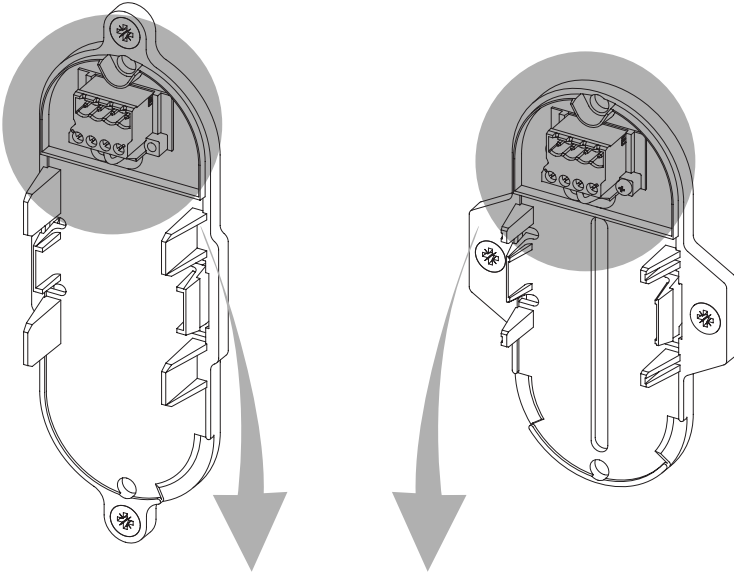

TRAILING EDGE



D95A5D - D95A3D

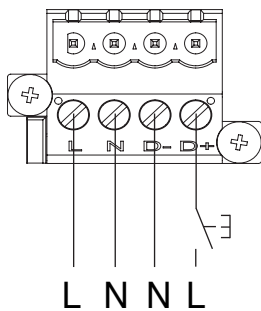
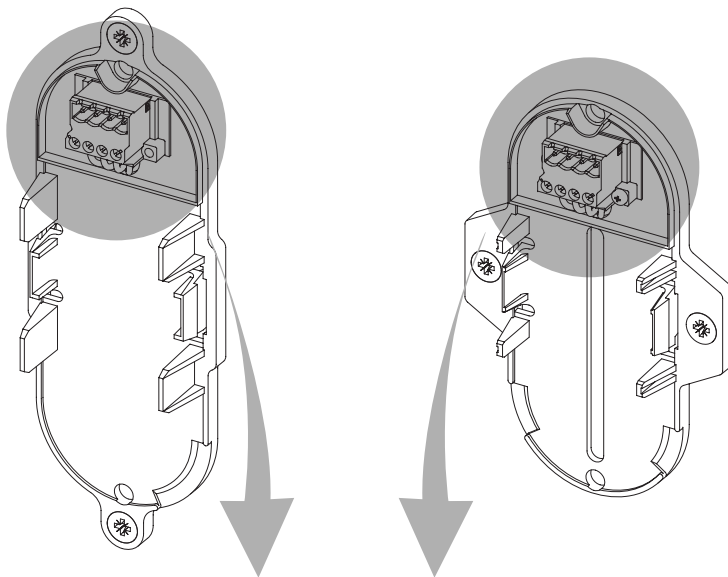

PUSH DIM



D95A5D - D95A3D

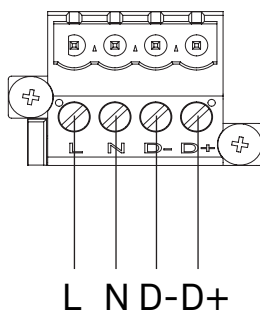
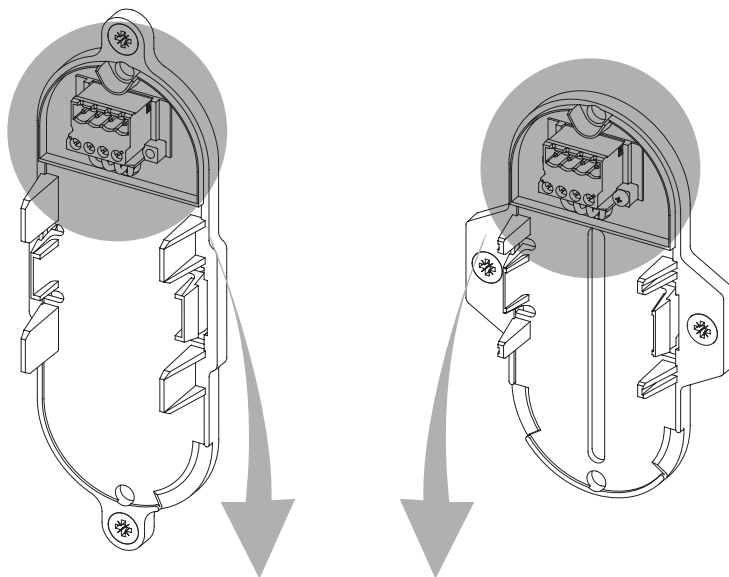

1.3

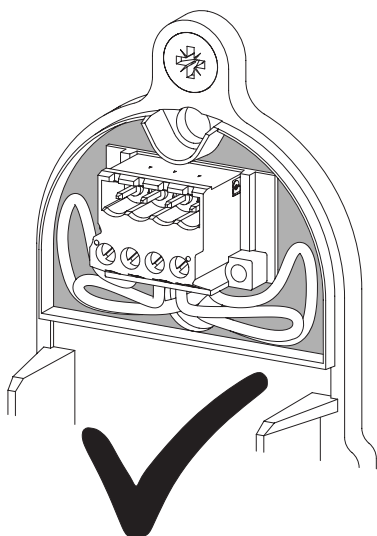
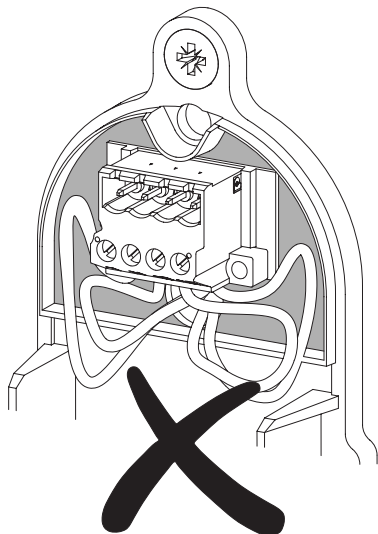

2

D95A5 - D95A5D

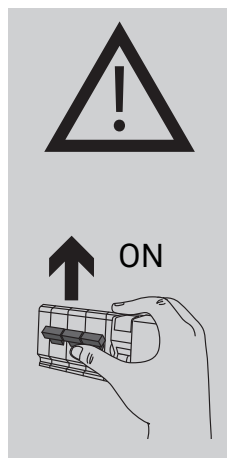
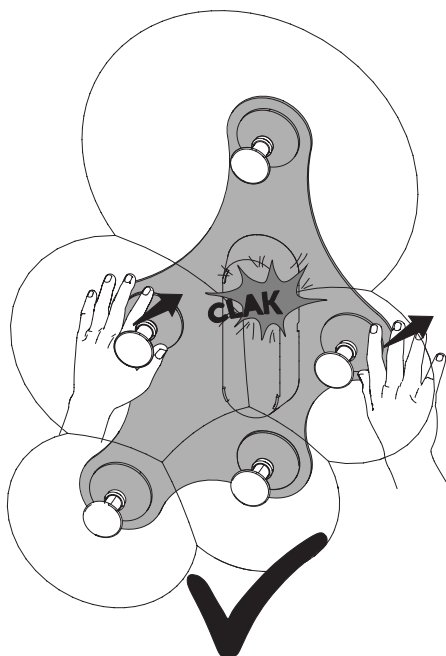
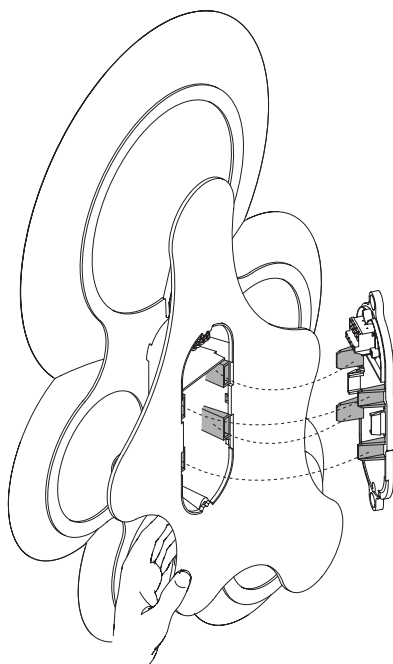
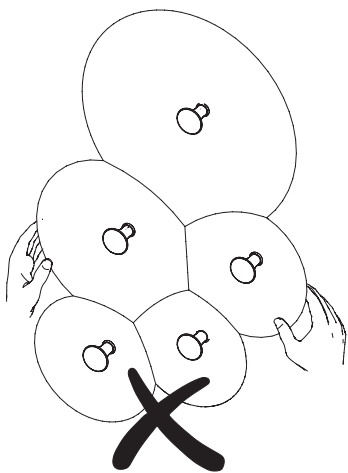

D95A3 - D95A3D

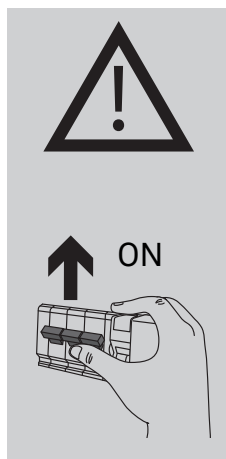
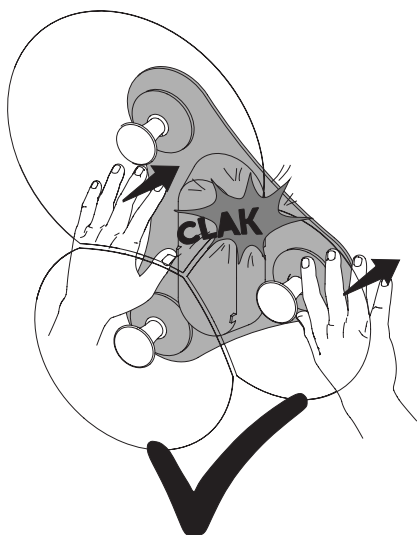
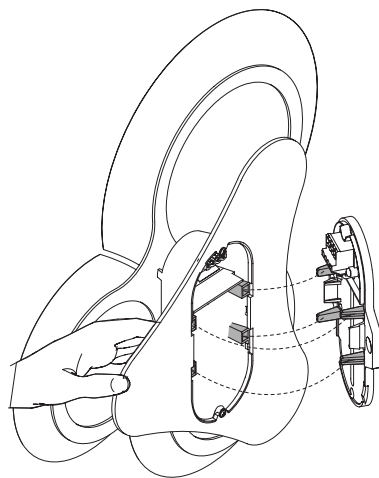
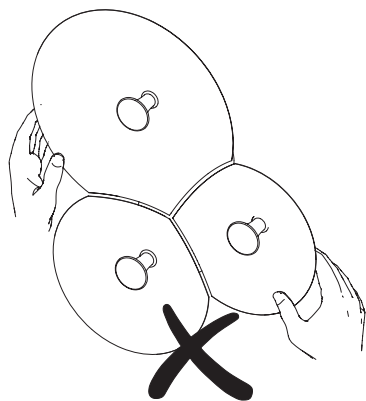

3 D95A5 - D95A5D

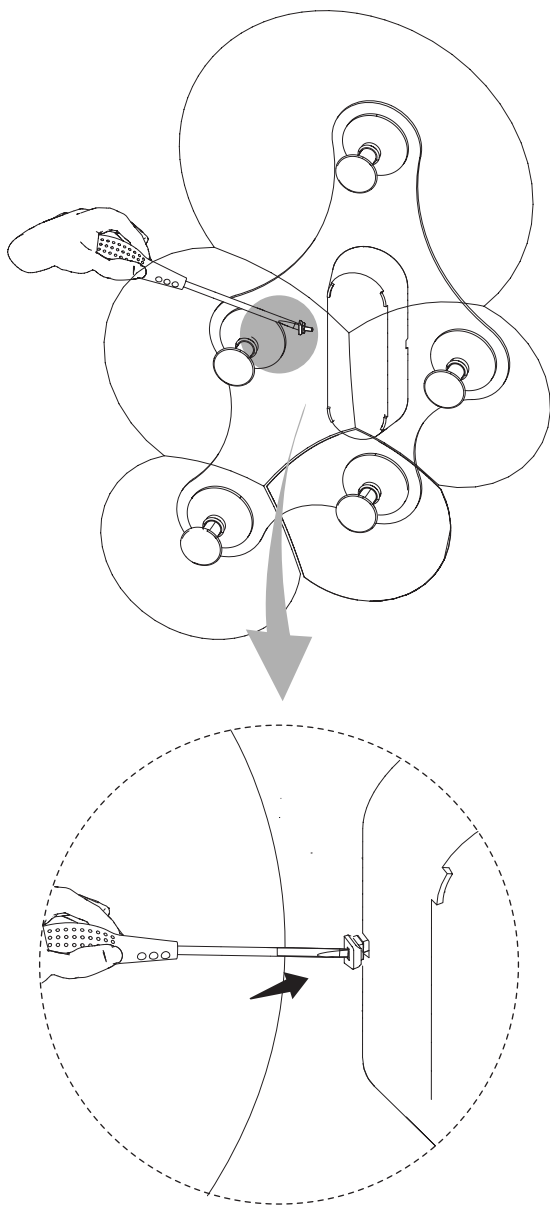

D95A3 - D95A3D

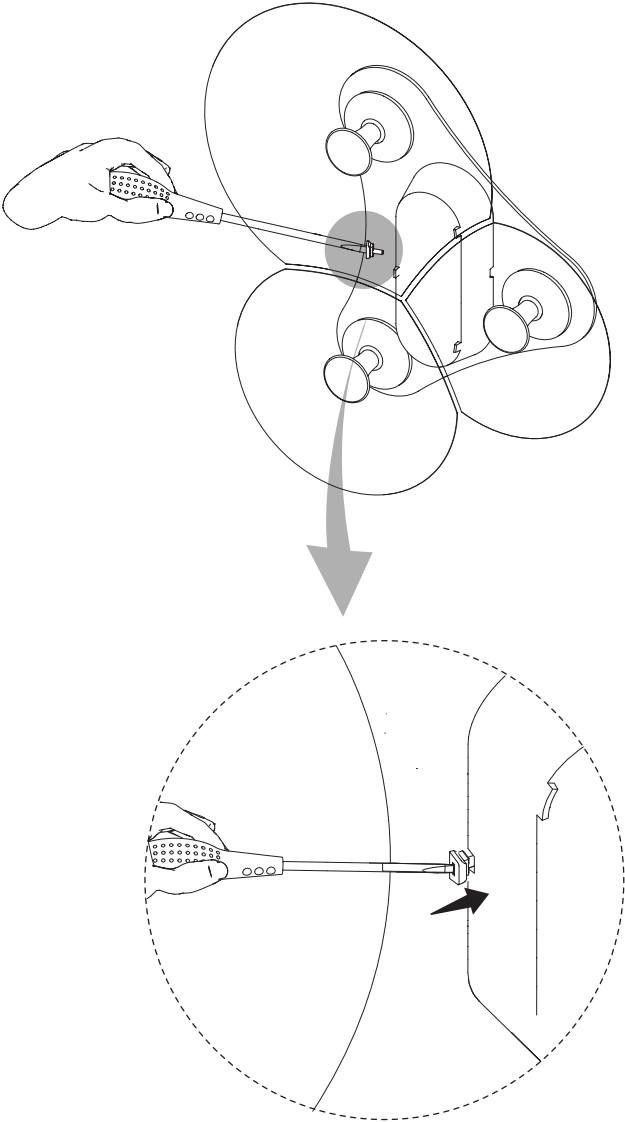



D95A5 - D95A5D

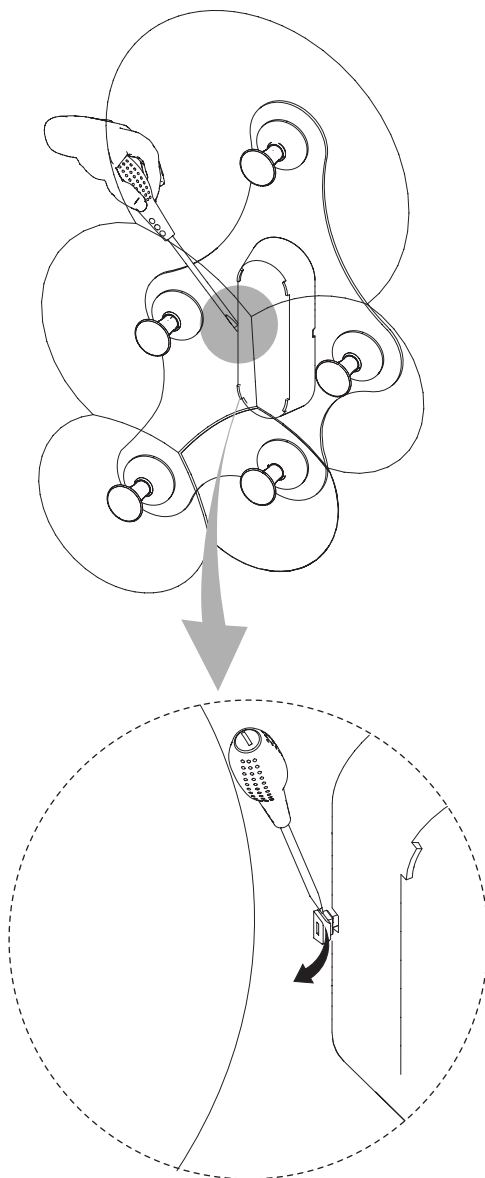
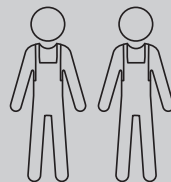

D95A5 - D95A5D

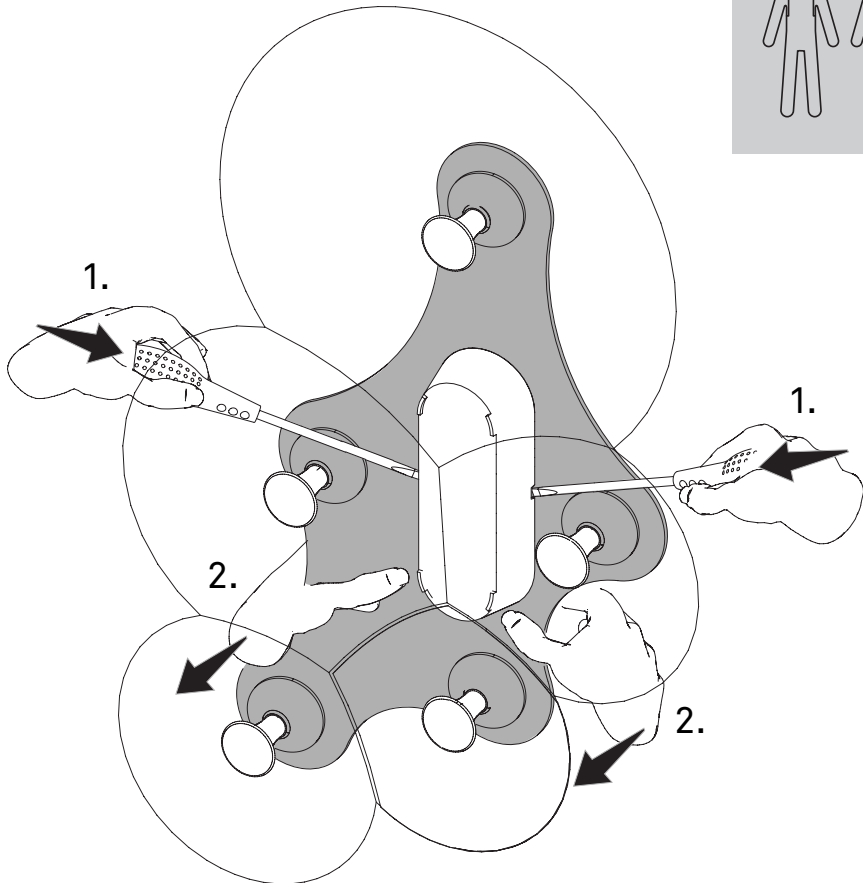
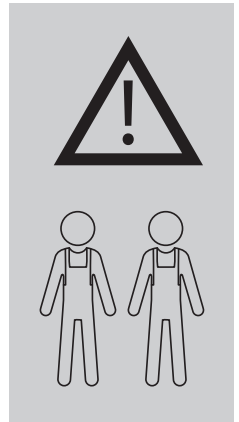



D95A3 - D95A3D

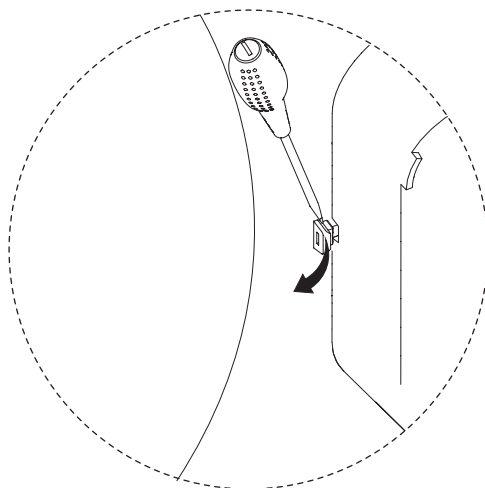
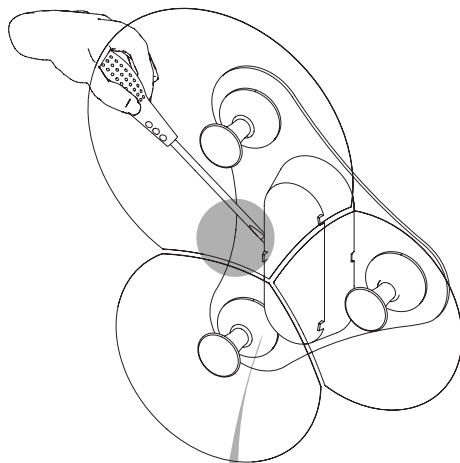
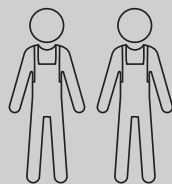

D95A3 - D95A3D

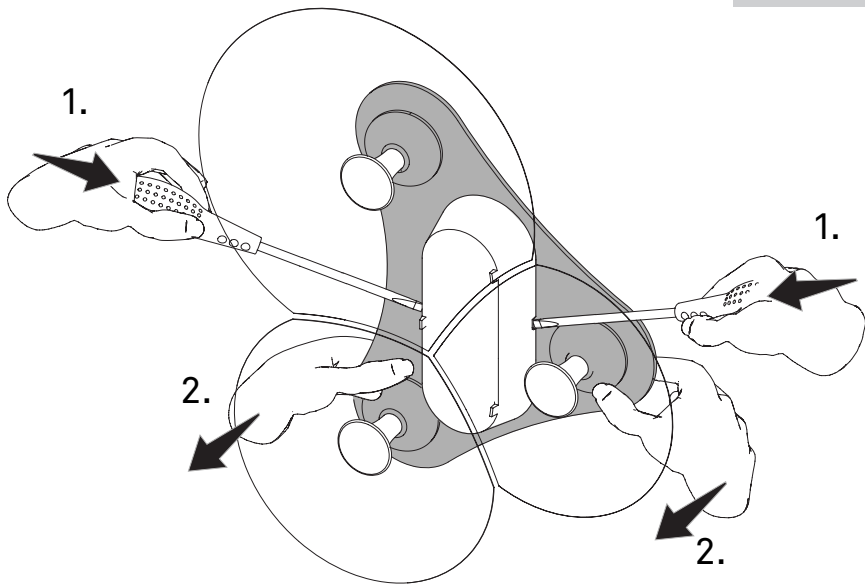
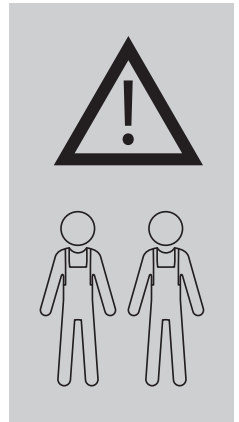

4

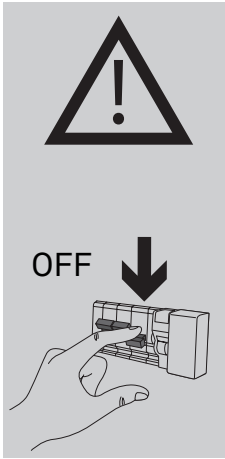

1.

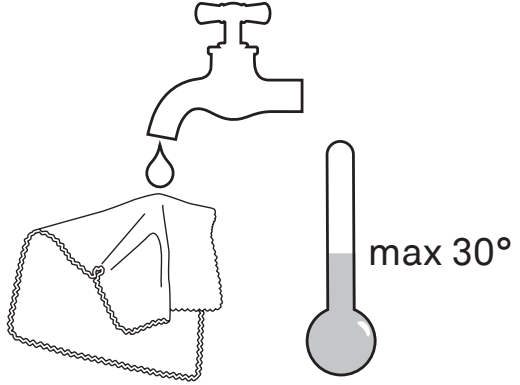

2.



3.

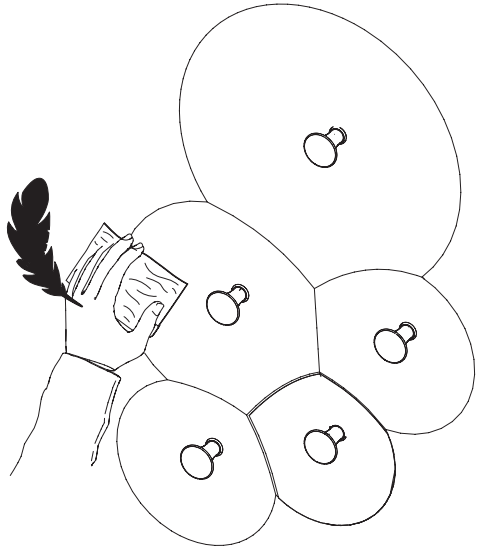



www.luceplan.com

D95010001