

Occhio

Mito sospeso var up

Montageanleitung
Mounting instructions

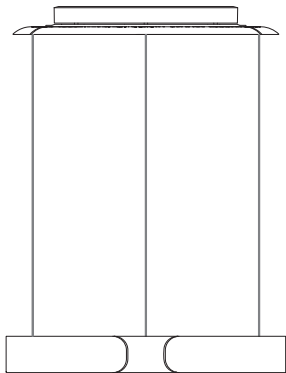

+ DALI

Inhalt / Contents

Sicherheitshinweise	04	Safety precautions	05
Produktbeschreibung	06	Product description	07
Schritt 1		Step 1	
Steuerung	09	Control	09
Mito set box (standard)	11	Mito set box (standard)	11
Mito »air« box (optional)	21	Mito »air« box (optional)	21
Mito DALI box (optional)	29	Mito DALI box (optional)	29
Schritt 2		Step 2	
Montage	35	Mounting	35
Seiteneinspeisung (optional)	43	Sideways inlet (optional)	43
Montage DALI	51	Mounting DALI	51
Durchverdrahtung (optional)	60	Through wiring (optional)	60
Seiteneinspeisung (optional)	63	Sideways inlet (optional)	63
Steuerung mit der Occhio air App (optional)	71	Control using the Occhio air app (optional)	71
Steuerung mit dem Occhio air controller (optional)	79	Control using the Occhio air controller (optional)	79
Anhang	83	Appendix	83
Pflegehinweise	84	Care instructions	84
Info & Kontakt	85	Information & contact	85
Technische Daten	86	Technical data	88

Sicherheitshinweise

Lesen Sie die Montage-/Gebrauchsanweisung sorgfältig durch, bevor Sie die Leuchte installieren. Beachten Sie die Sicherheitshinweise in dieser Anleitung genau und bewahren Sie die Anleitung auf.



Dieses Zeichen macht Sie auf eine gefährliche Situation aufmerksam, die eine schwere Verletzung oder den Tod nach sich ziehen kann, wenn sie nicht beachtet wird. Es macht Sie zudem auf mögliche Sachschäden und andere wichtige Informationen in Verbindung mit diesem Produkt aufmerksam.



Die Montage von Elektrokomponenten darf nur von qualifiziertem Fachpersonal durchgeführt werden. Reparaturarbeiten dürfen nur von autorisiertem Fachpersonal oder dem Hersteller durchgeführt werden. Vor allen Arbeiten an der Leuchte (Installation, Reinigung etc.) diese unbedingt vom Stromnetz trennen.



Dieses Zeichen macht Sie auf Situationen aufmerksam, bei denen Sie direkt in das Licht der LED blicken könnten. Dies kann zu Nachbildern und bei längerer Dauer zu Schädigungen der Augen führen.



Sicherheitsabstand zu brennbaren Objekten einhalten: 20 cm!



Dieses Zeichen macht Sie auf heiße Oberflächen aufmerksam, deren Berührung Verbrennungen zur Folge haben können.

Achtung: Die Oberfläche der Leuchte kann nach längerer Betriebsdauer heiß sein! Vor allen Arbeiten an der Leuchte (Montage usw.), Leuchte immer ausschalten und mindestens 30 Minuten abkühlen lassen.

Safety precautions

Read through the mounting/ use instructions carefully before installing the luminaire. Follow the safety precautions in these instructions closely and keep the instructions in a safe place.



This symbol warns you of a dangerous situation which could lead to serious injury or even death if the instructions are not observed. It also draws your attention to possible material damage and provides other important information in connection with this product.



The assembly and installation of electrical components must be carried out only by qualified personnel. Repairs must be carried out only by authorised, qualified personnel or the manufacturer. Before performing any work on the luminaire (installation, cleaning, etc.), it must be disconnected from the mains supply.



This symbol draws your attention to situations in which you could look directly into the light of the LED. This may cause an after-image effect and may result in damage to the eyes if you look at the light directly for prolonged periods.



Maintain the minimum safety distance from flammable materials: 20 cm.



This symbol warns you of hot surfaces, which could cause burns if touched.

Caution: When used for prolonged periods, the surface of the luminaire can become hot. Before performing any work on the luminaire (fitting the luminaire etc.), always switch the luminaire off and let it cool for at least 30 minutes.

Produktbeschreibung

Ringförmige LED Pendelleuchte mit beidseitigem Lichtaustritt und einem Durchmesser von 40 cm oder 60 cm.

Es stehen zwei Lichtwirkungen zur Wahl. table (wide) für die Anwendung über Tischen – breit abstrahlendes Licht nach unten und oben. room (narrow) für frei im Raum hängende Leuchten – gebündeltes Licht nach unten, diffuses Licht nach oben.

Die Pendellänge ist stufenlos einstellbar von 50–200 cm.

Version mit integriertem Vorschaltgerät für Aufputzmontage, Anschluss an 230 V AC Netzspannung. Steuerbar über »touchless control« (am head), Occhio air und DALI, alternativ dimmbar via Phasenabschnittdimmer*.

Die Farbtemperatur ist stufenlos steuerbar via »touchless control«, Occhio air oder DALI von 2700–4000 K oder voreinstellbar (2700 / 3000 / 3500 / 4000 K).

* Liste kompatibler Dimmer: www.occhio.com/dim, Phasenabschnittdimmer, »touchless control«, Occhio air und DALI nicht kombinierbar

Product description

Annular LED suspended luminaire with double-sided light emission and a diameter of 40 cm or 60 cm.

There is a choice of two lighting effects. table (wide) for use over tables – wide light beam downwards and upwards. room (narrow) for freely suspended luminaire lighting – concentrated light beam directed downwards, diffused light directed upwards.

The suspension length is continuously adjustable from 50 to 200 cm.

Version with integrated power supply unit for mounting on plaster surfaces; connection to 230 V AC mains voltage. Can be controlled via »touchless control« (on the head), Occhio air and DALI; alternatively, dimmable via a trailing-edge phase cut dimmer*.

The color temperature can be continuously controlled via »touchless control«, Occhio air or DALI from 2700 to 4000 K or can be preset (2700 / 3000 / 3500 / 4000 K).

* For a list of compatible dimmers, see www.occhio.com/dim_en, trailing-edge phasecut dimmer, »touchless control«, Occhio air and DALI not combinable

Steuerung

Funktionen / Steuerungsmöglichkeiten der Leuchte einstellen.

Control

Set functions / control options of the luminaire.

Mito set box (standard)

Seite / page 11

Mito »air« box (optional)

Seite / page 21

Mito DALI box (optional)

Seite / page 29

Mito set box
(standard)

Mito set box (standard)

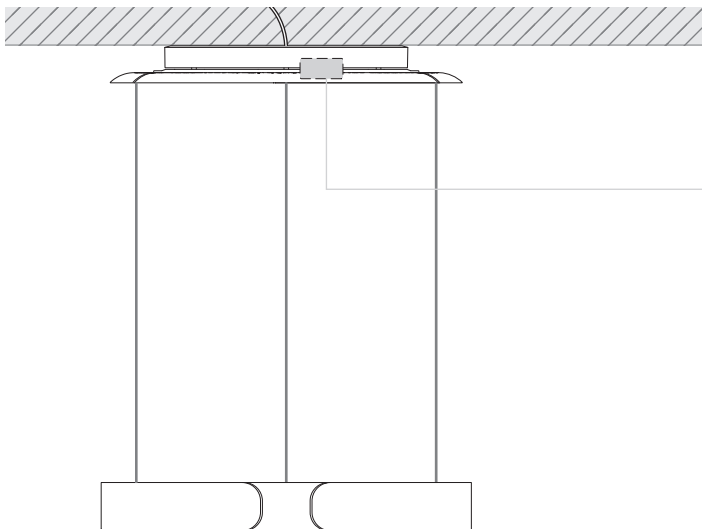

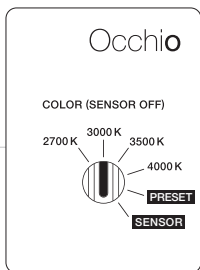

SENSOR = »touchless control«*

Gestensteuerung / gesture control (Seite / page 14)

- schalten / switching
- dimmen / dim
- up / down fading
- color tune

PRESET = PRESET**

extern schalten und dimmen / switch and dim externally
(Seite / page 16)

- up / down Verhältnis einstellbar (5 Stufen)
up / down relation adjustable (5 stages)
- Farbtemperatur einstellbar (4 Stufen)
color temperature adjustable (4 stages)

COLOR (SENSOR OFF)

2700 K 3000 K 3500 K 4000 K = **color preset****

Farbtemperatur voreinstellbar, extern schalten und dimmen /
color temperature pre-settable switch and dim externally
(Seite / page 18)

- extern schalten und dimmen /
switch and dim externally

* **Nicht kombinierbar** mit einem externen
Phasenabschrittdimmer.

** **Kombinierbar** mit einem externen
Phasenabschrittdimmer.

* **Can not be combined** with an external
trailing-edge phasecut dimmer.

** **Can be combined** with an external
trailing-edge phasecut dimmer.

» touchless control «

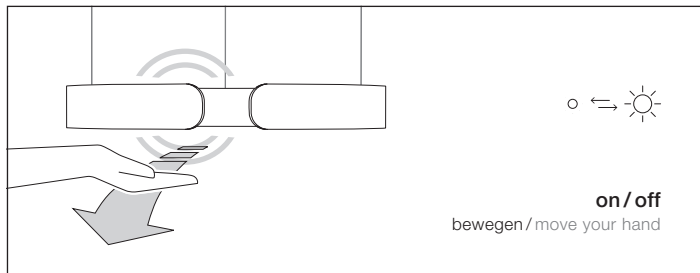
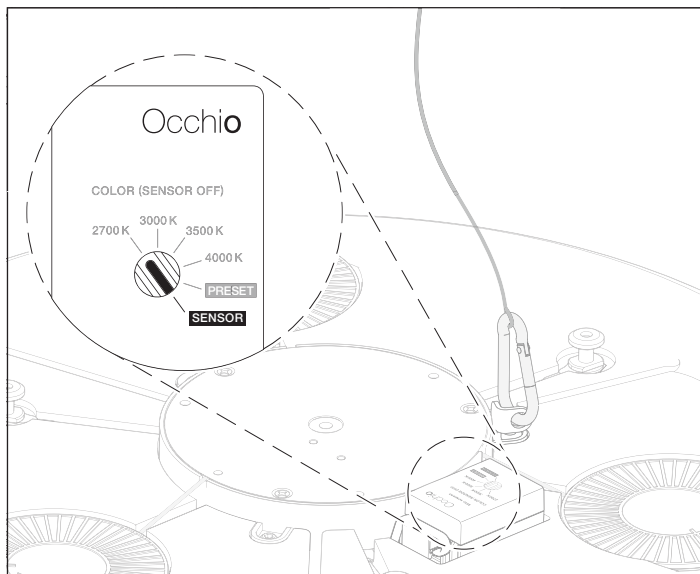

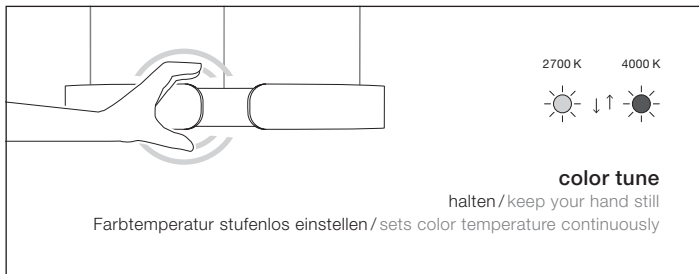
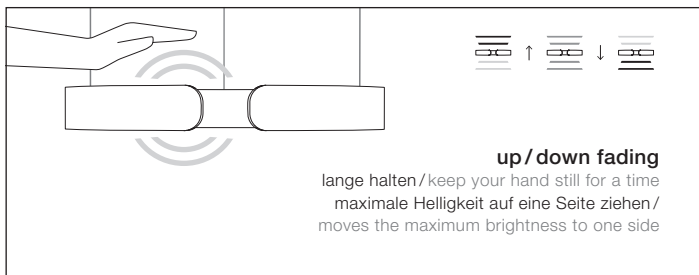
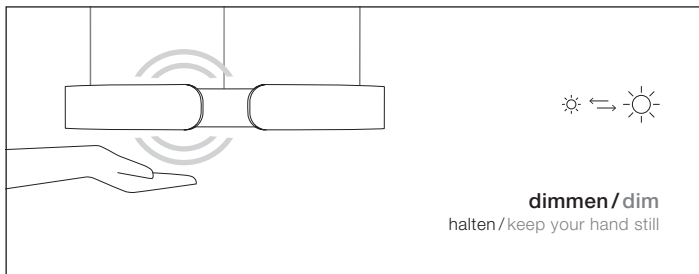

PRESET (Sensor aus / sensor off)

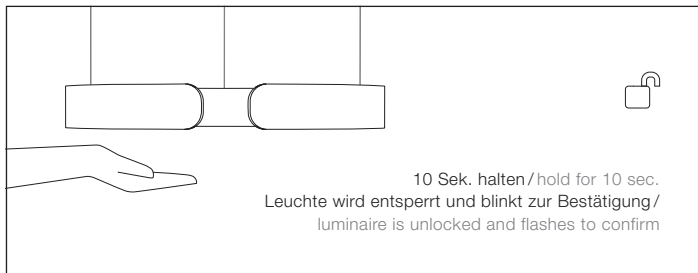
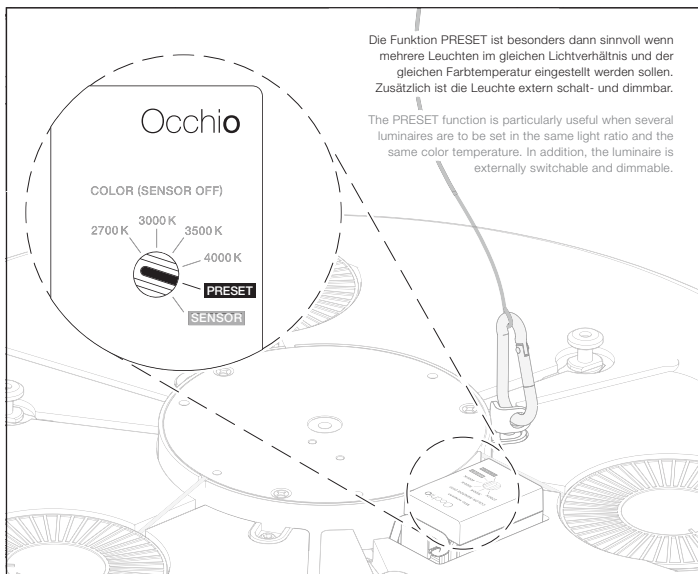



up/down

Verhältnis einstellbar / relation adjustable
lange halten / keep your hand still for a time
Lichtverhältnis in 5 Stufen einstellen / sets the lighting conditions in 5 stages

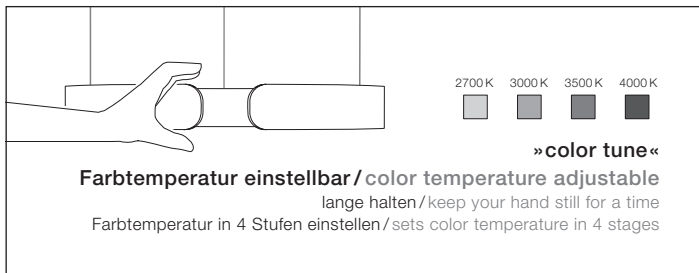

» color tune «

Farbtemperatur einstellbar / color temperature adjustable
lange halten / keep your hand still for a time
Farbtemperatur in 4 Stufen einstellen / sets color temperature in 4 stages

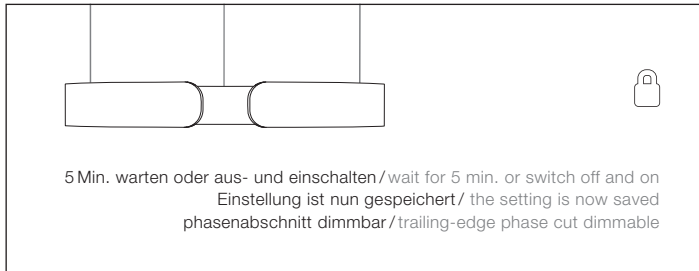

5 Min. warten oder aus- und einschalten / wait for 5 min. or switch off and on
Einstellung ist nun gespeichert / the setting is now saved
phasenabschnitt dimmbar / trailing-edge phase cut dimmable

color preset («touchless control« deaktiviert/
»touchless control« deactivated)

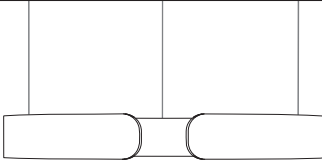
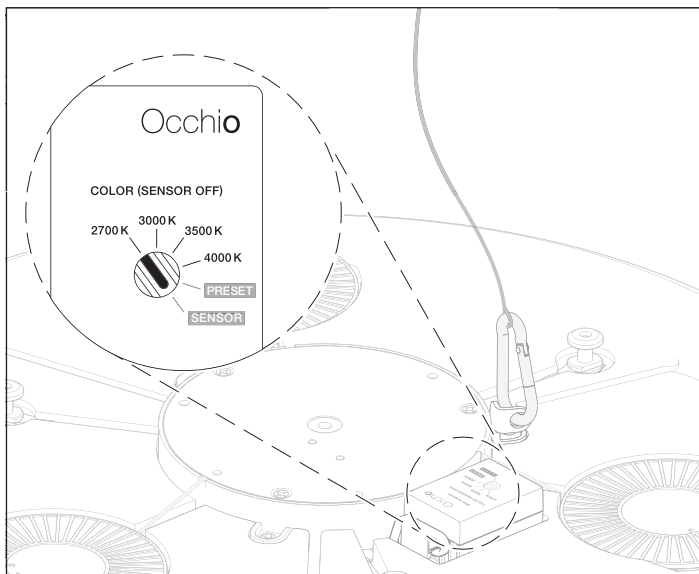



Farbtemperatur voreinstellbar
color temperature pre-settable
(2700 K, 3000 K, 3500 K, 4000 K)

Lichtverhältnis 50 % up und 50 % down / lighting conditions 50 % up and 50 % down
»touchless control« **deaktiviert** / »touchless control« **deactivated**
phasenabschnitt dimmbar / trailing-edge phase cut dimmable



Mito »air« box
(optional)

Mito »air« box (optional)

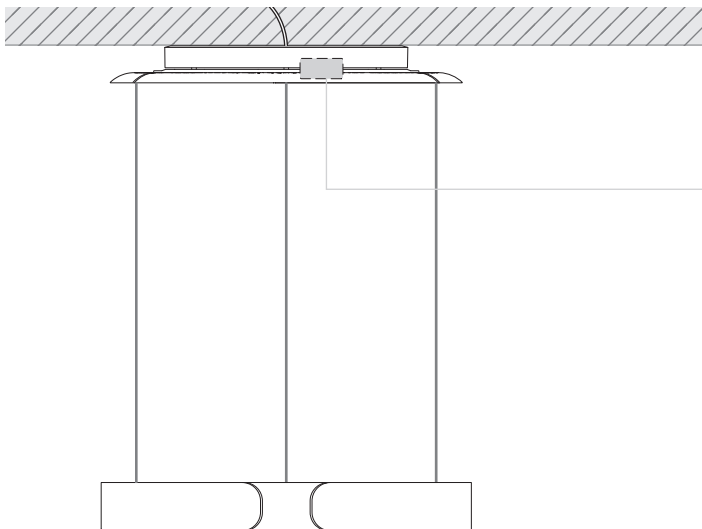

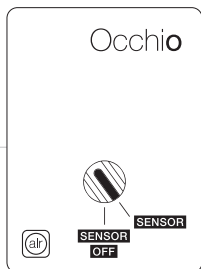

SENSOR = »touchless control« + »air«

Bluetooth- und Gestensteuerung / bluetooth and gesture control
(Seite / page 24)

- schalten / switching
- dimmen / dim
- up / down fading
- color tune

SENSOR OFF = »air«

Bluetoothsteuerung / bluetooth control (Seite / page 26)

- schalten / switching
- dimmen / dim
- up / down fading
- color tune

Nicht kombinierbar mit einem externen Phasenabschrittdimmer.

Can not be combined with an external trailing-edge phasecut dimmer.

» touchless control « + » air «

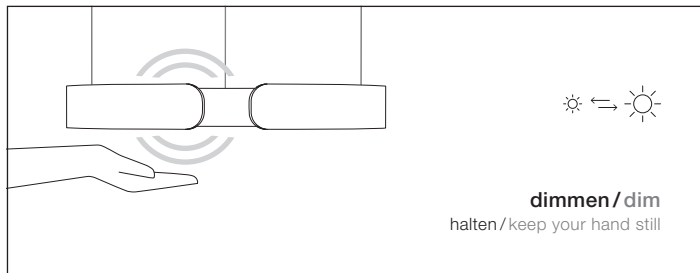
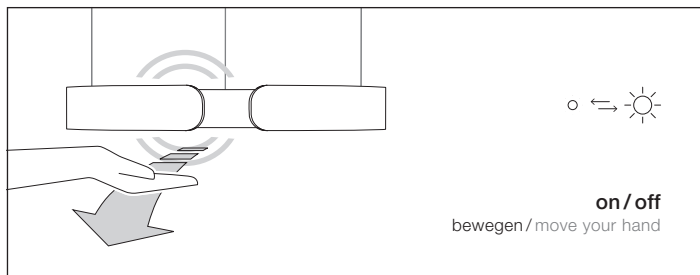
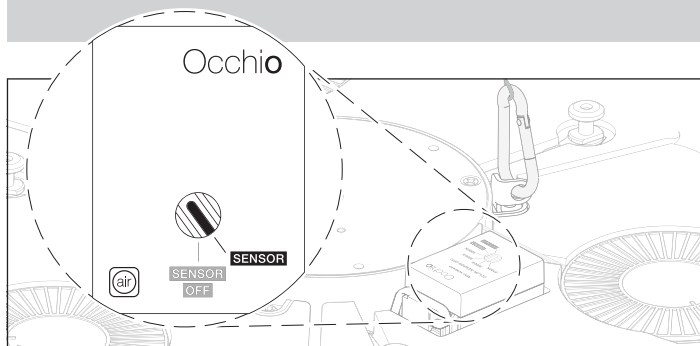

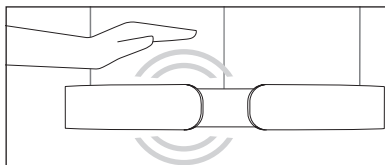

up/down fading

lange halten / keep your hand still for a time
maximale Helligkeit auf eine Seite ziehen /
moves the maximum brightness to one side

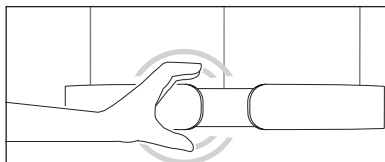

2700 K 4000 K

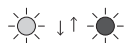

color tune

halten / keep your hand still
Farbtemperatur stufenlos einstellen / sets color temperature continuously



Steuerung via Occhio air, weitere Informationen ab Seite 71.
Control via Occhio air, for further information see page 71.

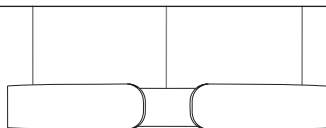
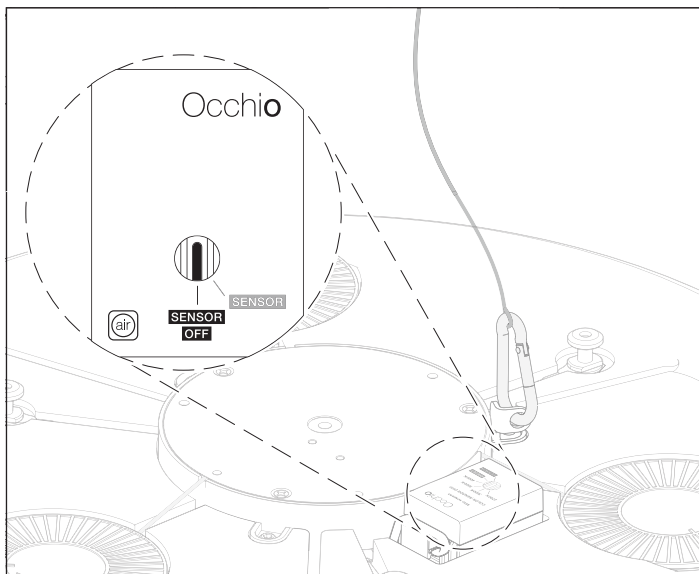

Steuerung via Occhio air, weitere Informationen ab Seite 71.
Control via Occhio air, for further information see page 71.



Mito DALI box
(optional)

Mito DALI box (optional)

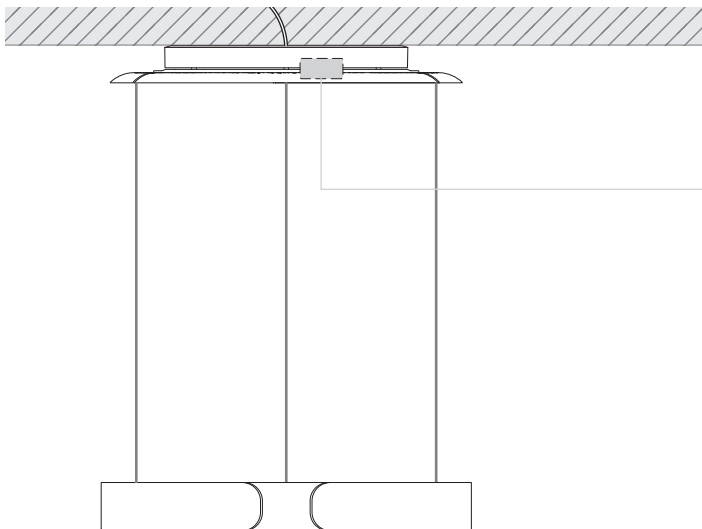



DALI

DALI-steuerung / DALI control
(Seite / page 32)

- schalten / switching
- dimmen / dim
- Steuerung von up / down light /
control up / down light
- color tune

DALI-Steuerung

DALI control

Jedem DALI-Strang können max. 32 Mito sospeso zugeordnet werden.

Die Mito sospeso benötigt zwei DALI-Adressen je Leuchte, dadurch sind Ober- und Unterseite über eine eigene DALI-Adresse steuerbar. Die max. Leistung wird erreicht wenn beide DALI-Leuchten (Ober- und Unterseite) auf max. Helligkeit eingestellt sind (45 W = 22 W up und 22 W down; 60 W = 30 W up und 30 W down).

Die Mito sospeso können in bis zu 16 Gruppen organisiert und mit zusätzlich 16 Szenen (vordefinierte Einstellungen) versehen werden.

Über eine DALI-Kurzadresse können sie einzeln angesteuert und eingestellt werden, zusätzlich ermöglicht es der bidirektionale Datenaustausch den Zustand/Status von einzelnen Leuchten abzufragen.

Detaillierte Hinweise sind unter www.occhio.com/dali zu finden.

A maximum of 32 Mito sospeso units can be assigned to each DALI circuit.

The Mito sospeso requires two DALI addresses per luminaire, which enables control of the top and bottom sides via their own respective DALI address. The maximum output is reached if both DALI luminaires (top and bottom side) are set to maximum brightness (45 W = 22 W up and 22 W down; 60 W = 30 W up and 30 W down).

The Mito sospeso units can be organized into as many as 16 groups and equipped with an additional 16 scenarios (predefined settings).

Using a DALI short address, they can be actuated and configured individually. In addition, the bi-directional data transfer lets users query the state/status of individual luminaires.

You can find more detailed information at www.occhio.com/dali.

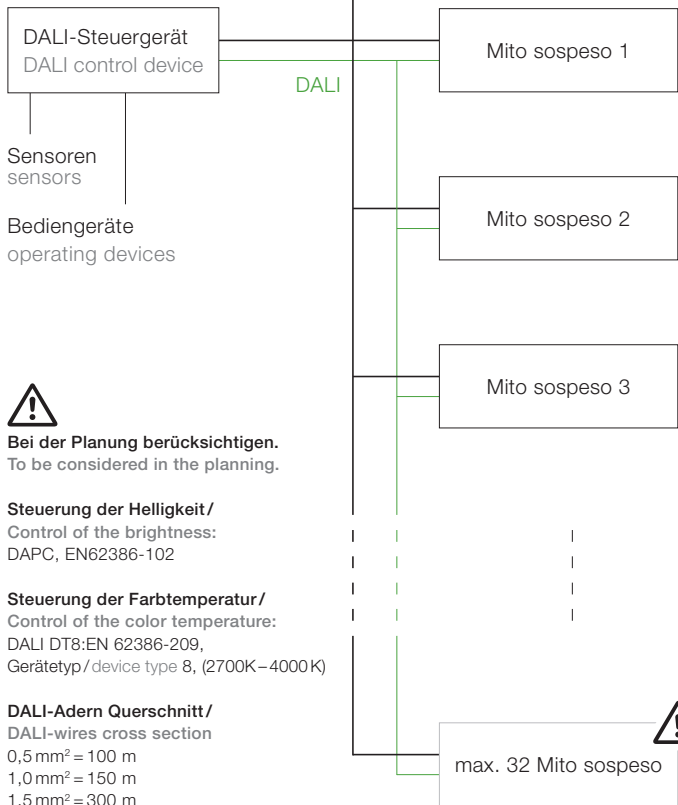

Bei der Planung berücksichtigen.
 To be considered in the planning.

Steuerung der Helligkeit /

Control of the brightness:
 DAPC, EN62386-102

Steuerung der Farbtemperatur /

Control of the color temperature:
 DALI DT8:EN 62386-209,
 Gerätetyp / device type 8, (2700K–4000K)

DALI-Adern Querschnitt /

DALI-wires cross section
 0,5 mm² = 100 m
 1,0 mm² = 150 m
 1,5 mm² = 300 m



Montage

Mounting

Mito set box (standard)
Mito »air« box (optional)

Mito DALI box (optional)
Seite / page 51

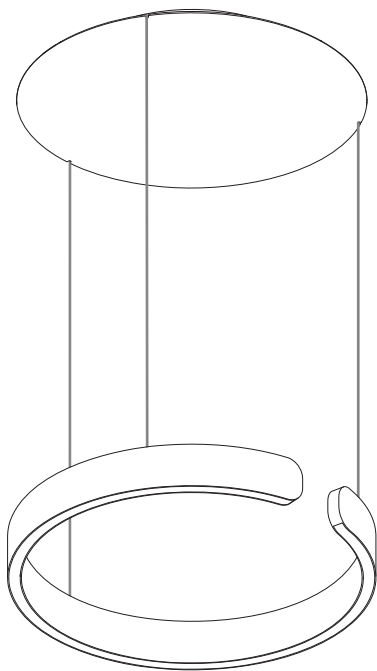

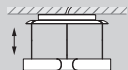

Deckenauslass / ceiling outlet
230V AC

Dübel / screw anchor

Deckenbefestigung inkl. Konverter /
ceiling mount incl. converter

Montageseil / mounting cord

Schrauben / screws

Baldachin mit integrierter
Höhenverstellung / canopy with
integrated height adjustment

Mito sospeso set box * /
Mito sospeso »air« box **

Mito sospeso head

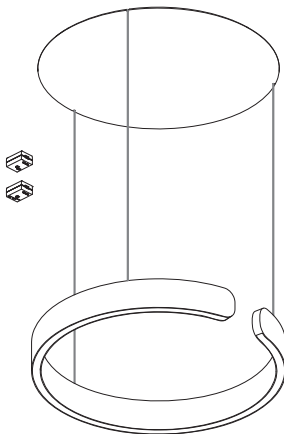
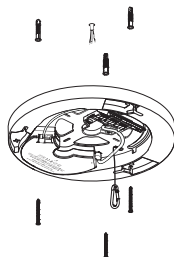

* standard ** optional

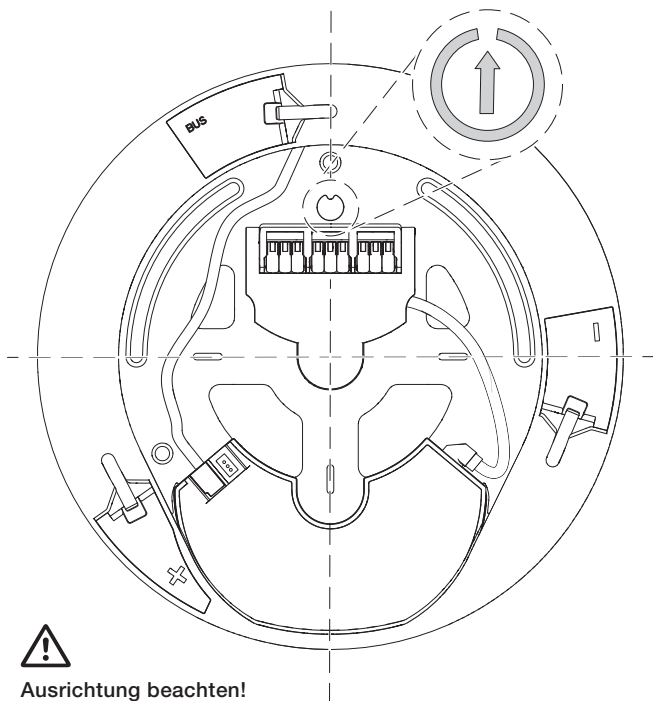

Ausrichtung beachten!
Observe alignment!

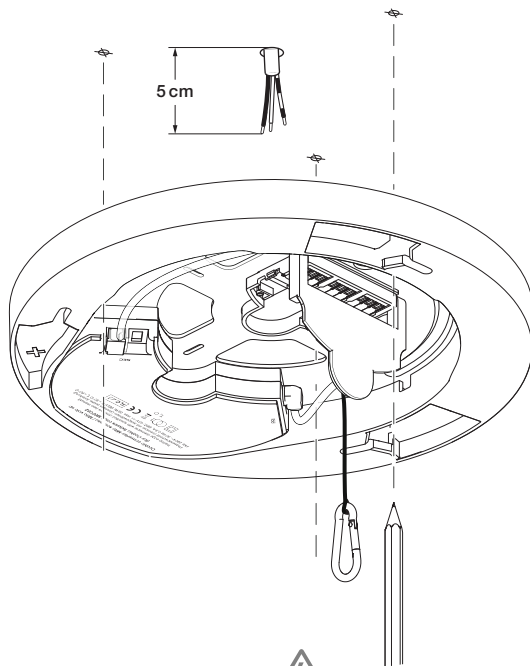
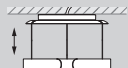

Achtung!
Vor der Montage alle
stromführenden Leitungen
vom Stromnetz trennen!



Caution!
Before mounting, disconnect
all currentcarrying lines
from the mains supply!

Montage / Mounting

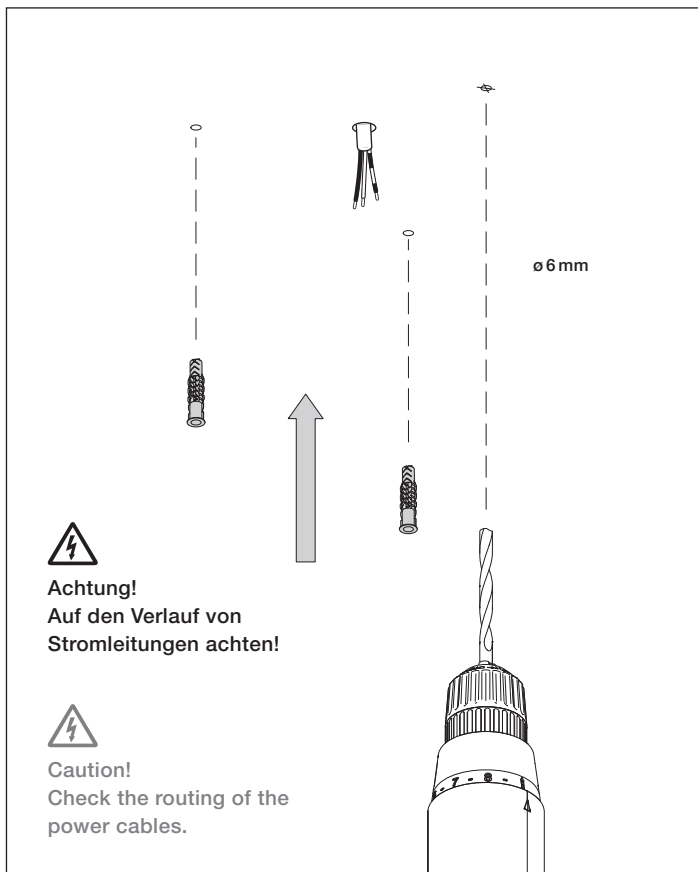

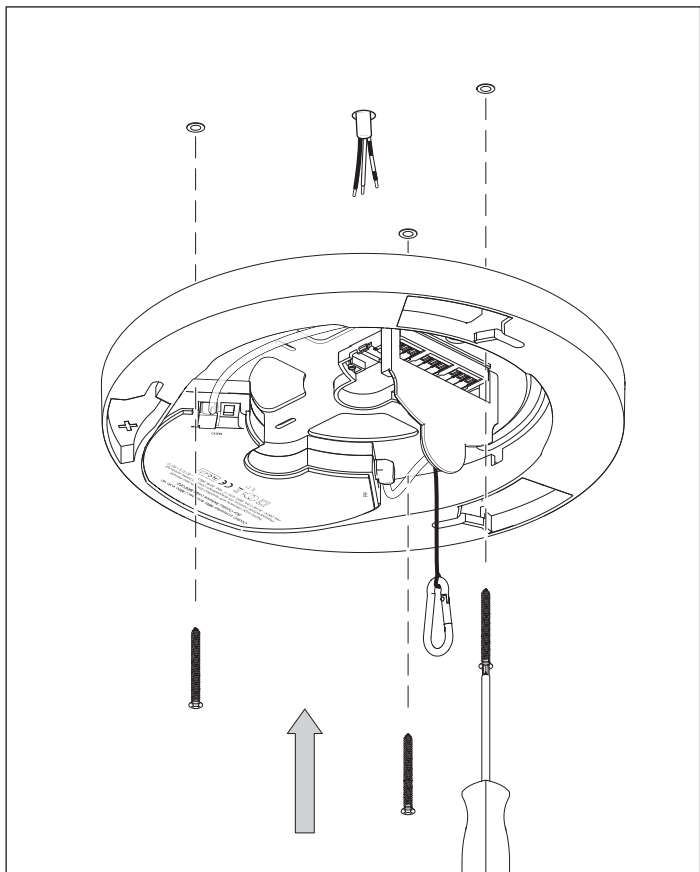
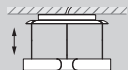

Montage / Mounting

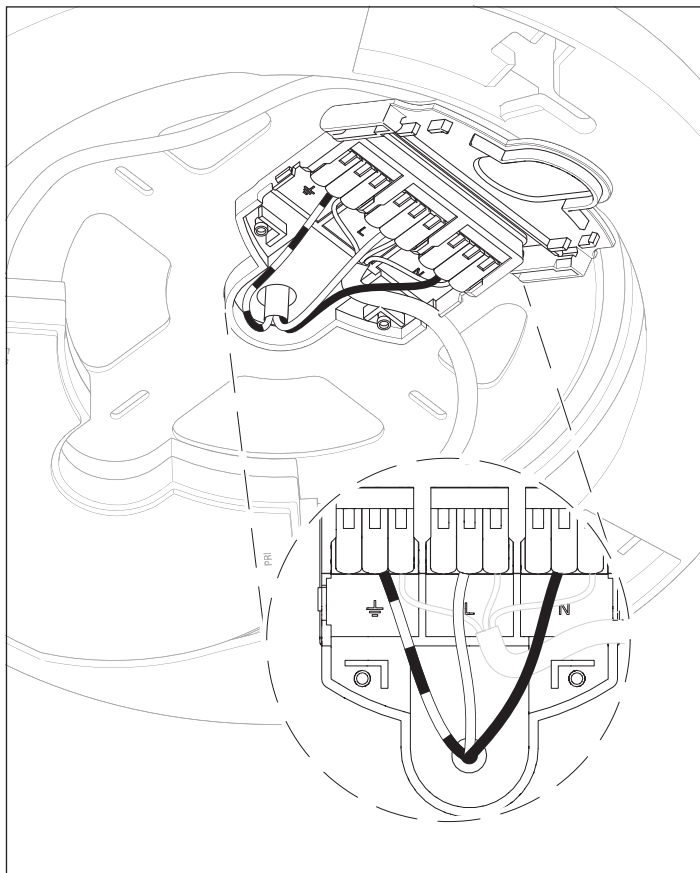

Seiteneinspeisung (optional) / Sideways inlet (optional)

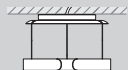

**Falls der Kabeleinlass der
Leuchte nicht verwendet
werden kann, besteht die
Möglichkeit der Seitenein-
speisung an drei Stellen.**

If the cable inlet of the
luminaire cannot be used,
it is possible to feed the
power from the side at
three points.



Montage / Mounting

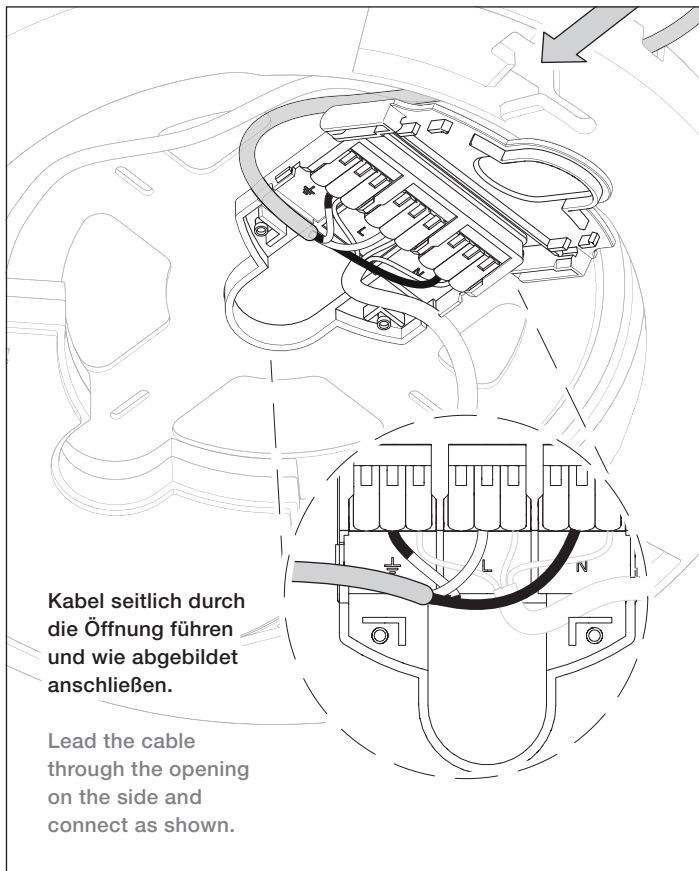

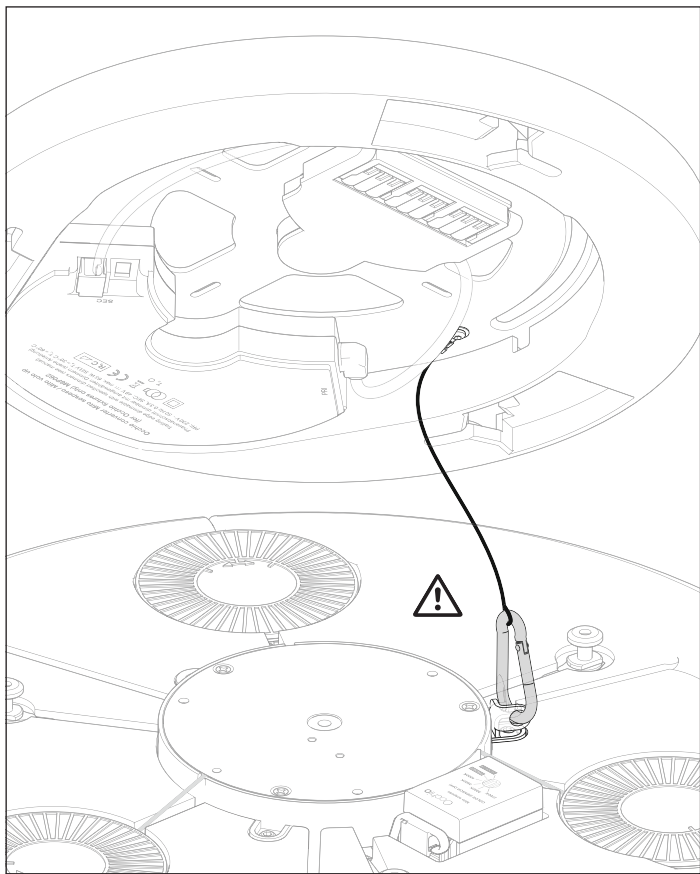
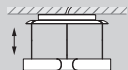

Montage / Mounting

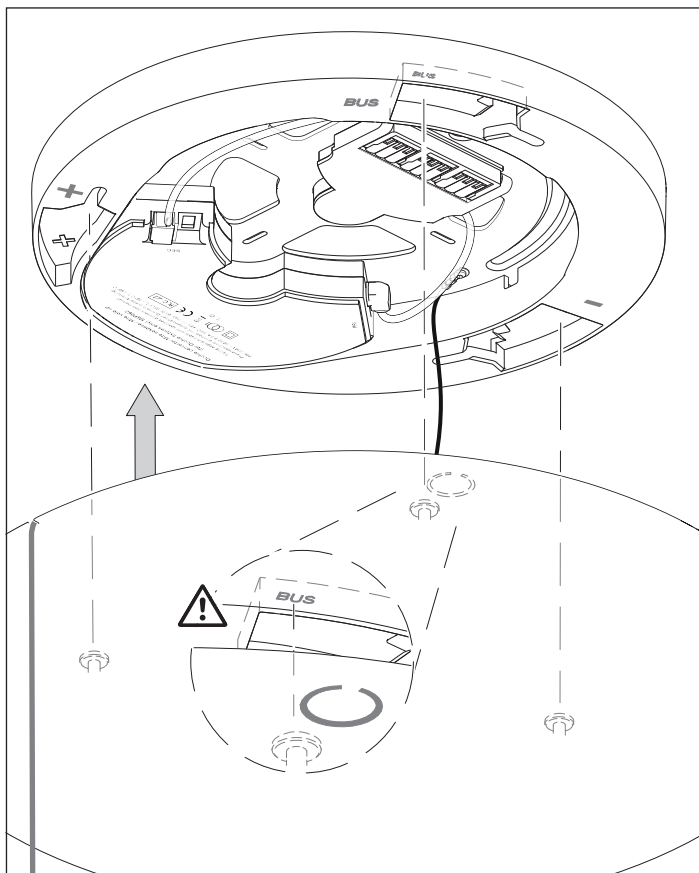

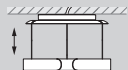

**Baldachin drehen, bis
dieser hörbar einrastet
und Markierung prüfen!**

Turn canopy until you
hear it click into place
and check sign!

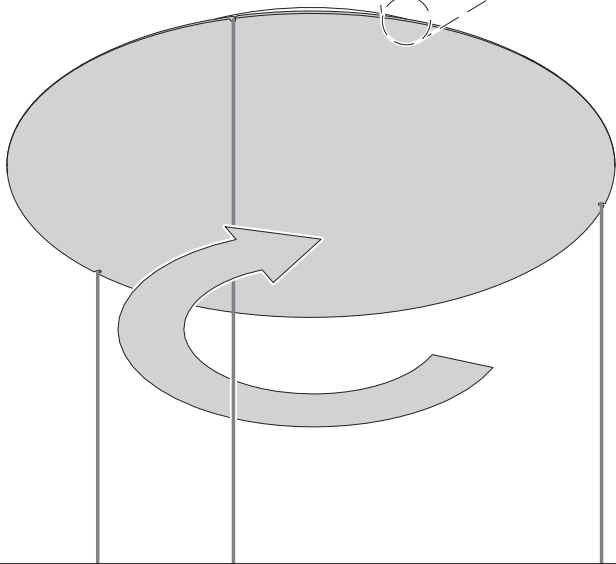
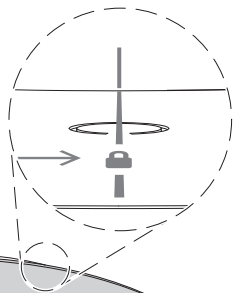

Feinjustierung fine adjustment

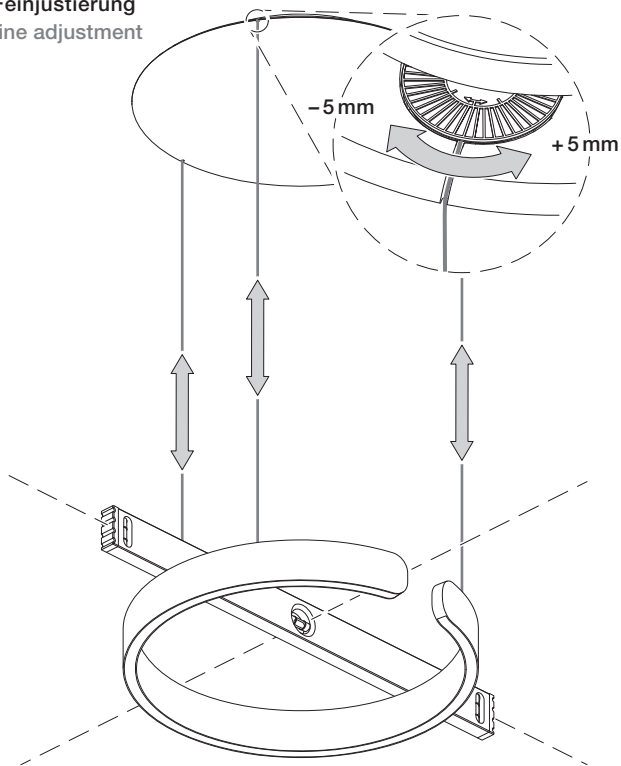

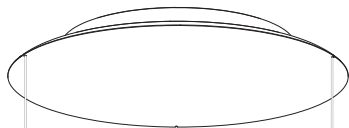
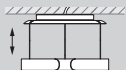

Die Leuchte ist nun fertig montiert.

The luminaire is now completely assembled.

Die Höhe kann nun stufenlos am head eingestellt werden.

The height can now be adjusted steplessly on the head

Montage DALI

Mounting DALI

Mito set box (standard)

Mito »air« box (optional)

Seite / page 35

Montage DALI / Mounting DALI

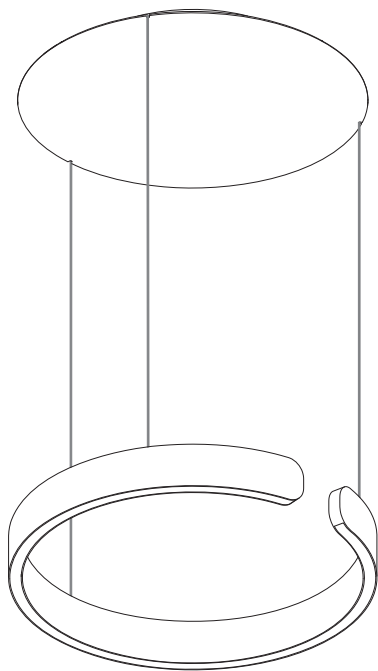

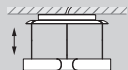

Deckenauslass / ceiling outlet
230V AC

Dübel / screw anchor

Deckenbefestigung inkl. Konverter /
ceiling mount incl. converter

Montageseil / mounting cord

Schrauben / screws

Baldachin mit integrierter
Höhenverstellung / canopy with
integrated height adjustment

Mito sospeso DALI box



Mito sospeso head

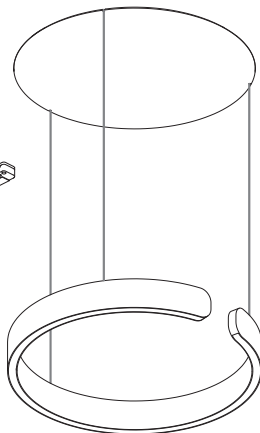
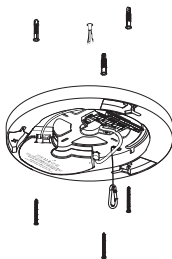

Montage DALI / Mounting DALI

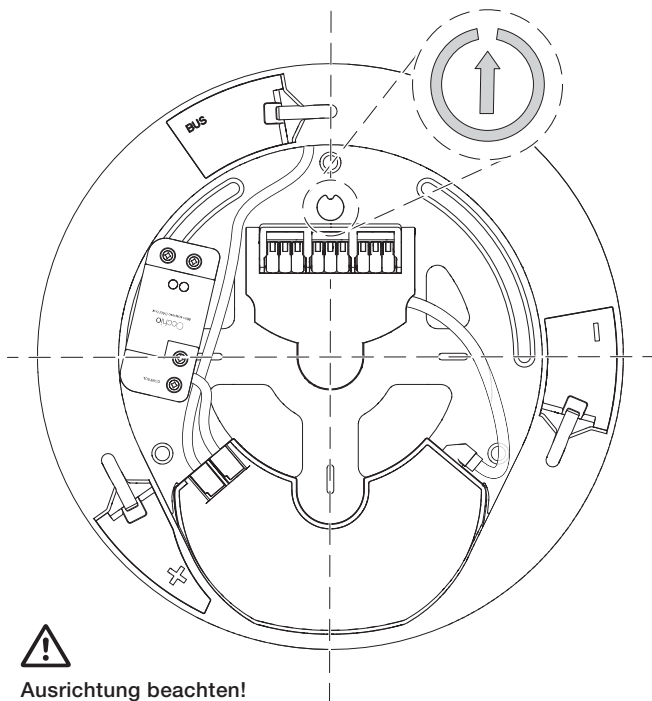

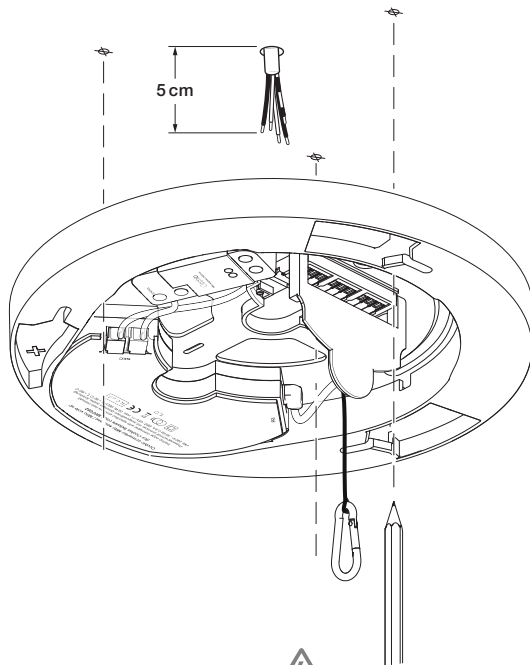
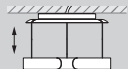

Achtung!
Vor der Montage alle
stromführenden Leitungen
vom Stromnetz trennen!



Caution!
Before mounting, disconnect
all currentcarrying lines
from the mains supply!

Montage DALI / Mounting DALI

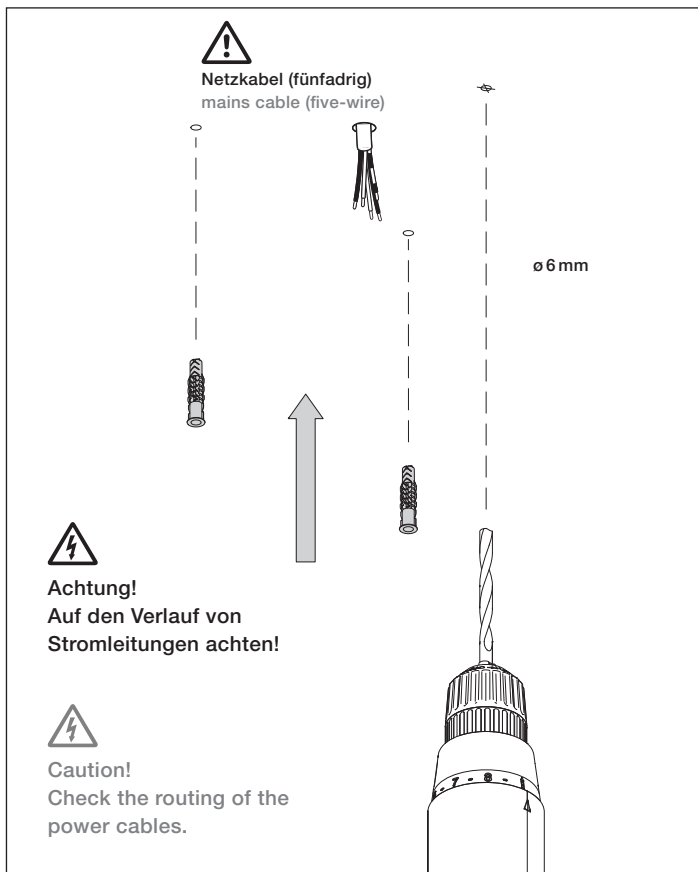

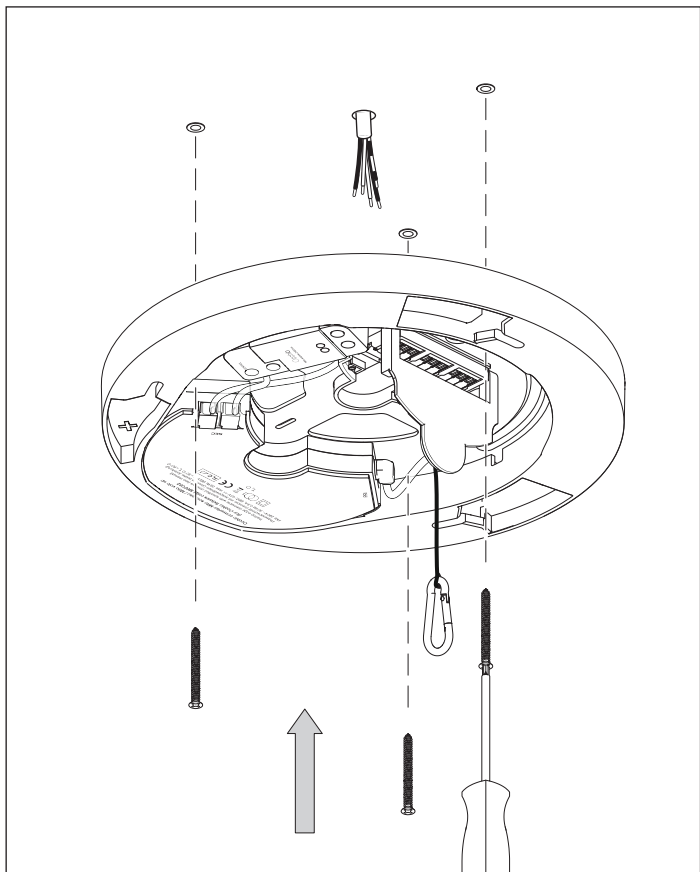
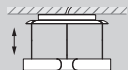

Montage DALI / Mounting DALI

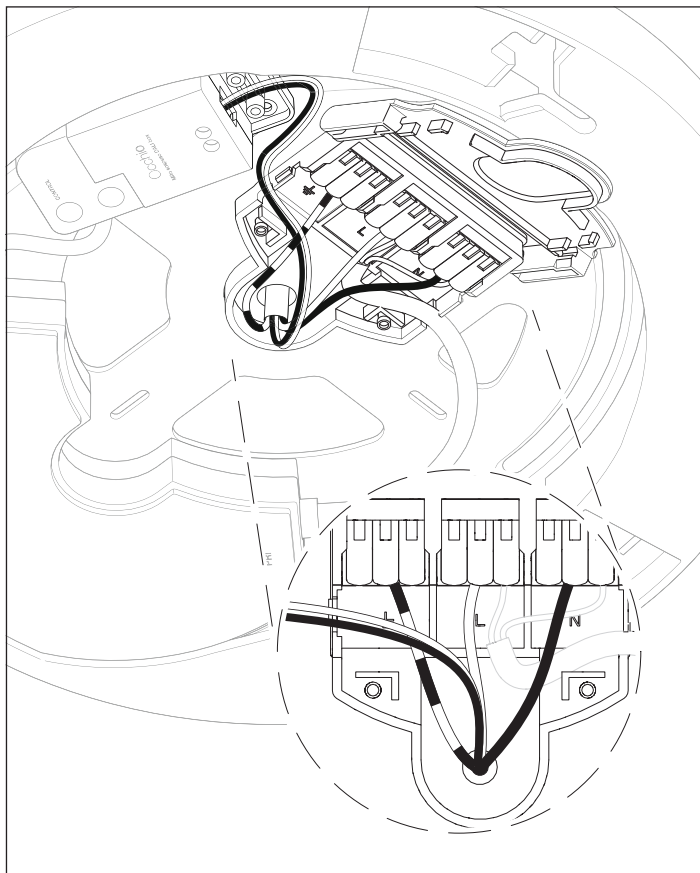

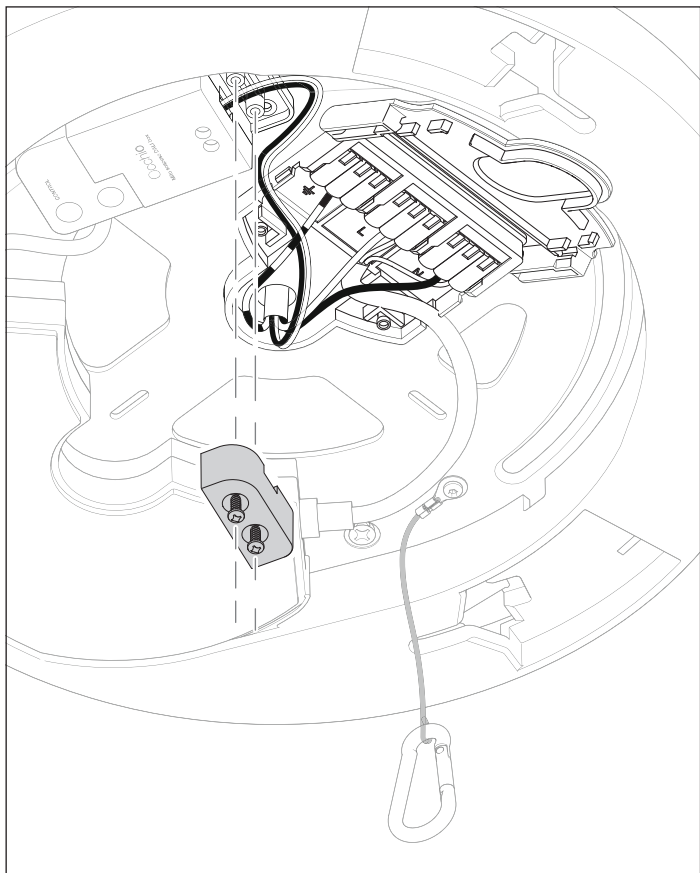
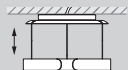

Durchverdrahtung (optional) Through wiring (optional)

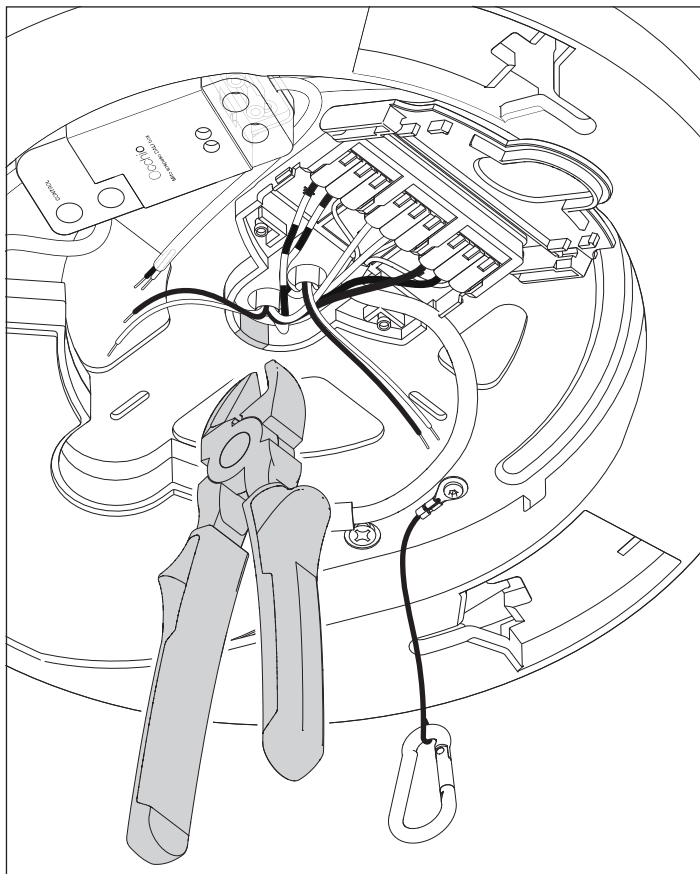

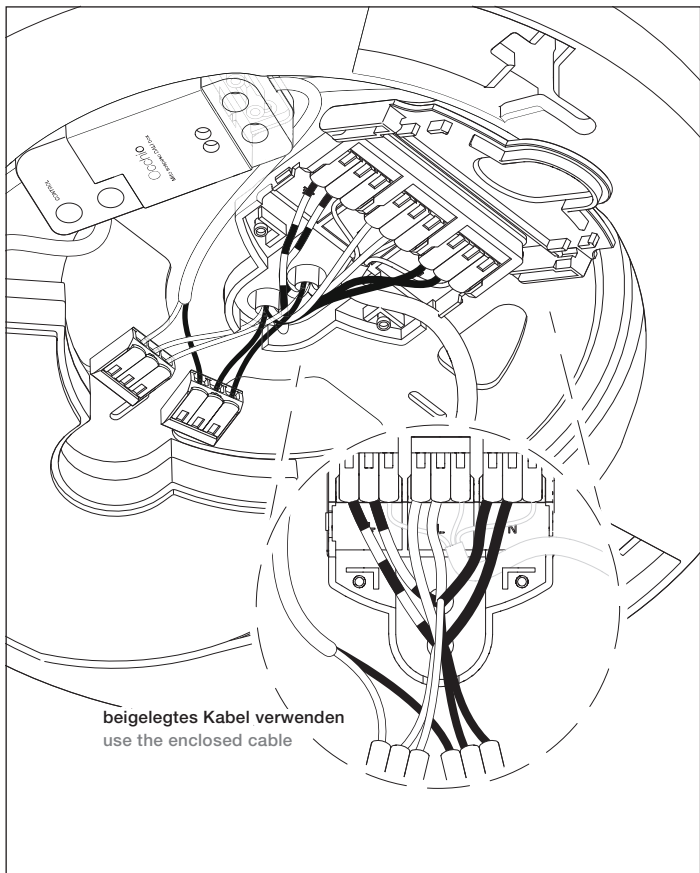
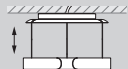

beigelegtes Kabel verwenden
use the enclosed cable

Montage DALI / Mounting DALI

Falls der Kabeleinlass der Leuchte nicht verwendet werden kann, besteht die Möglichkeit der Seiteneinpeisung an drei Stellen.

If the cable inlet of the luminaire cannot be used, it is possible to feed the power from the side at three points.

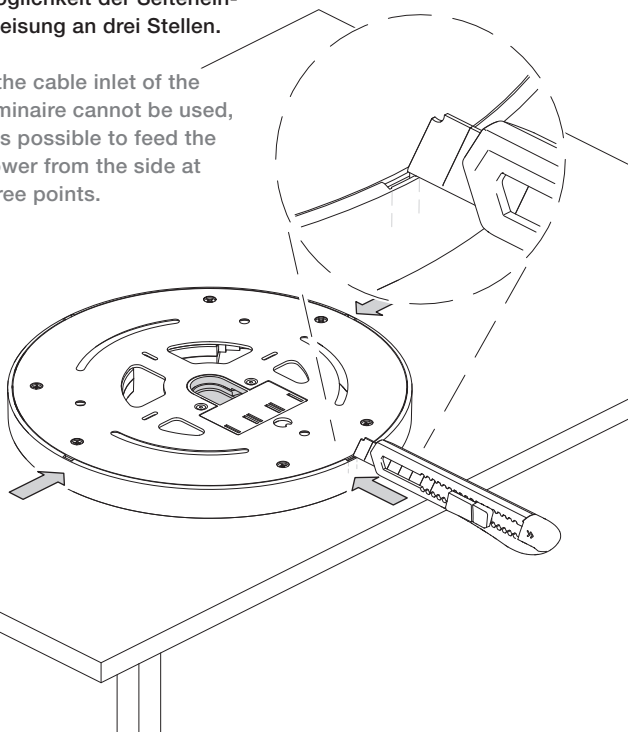

Seiteneinspeisung (optional) / Sideways inlet (optional)

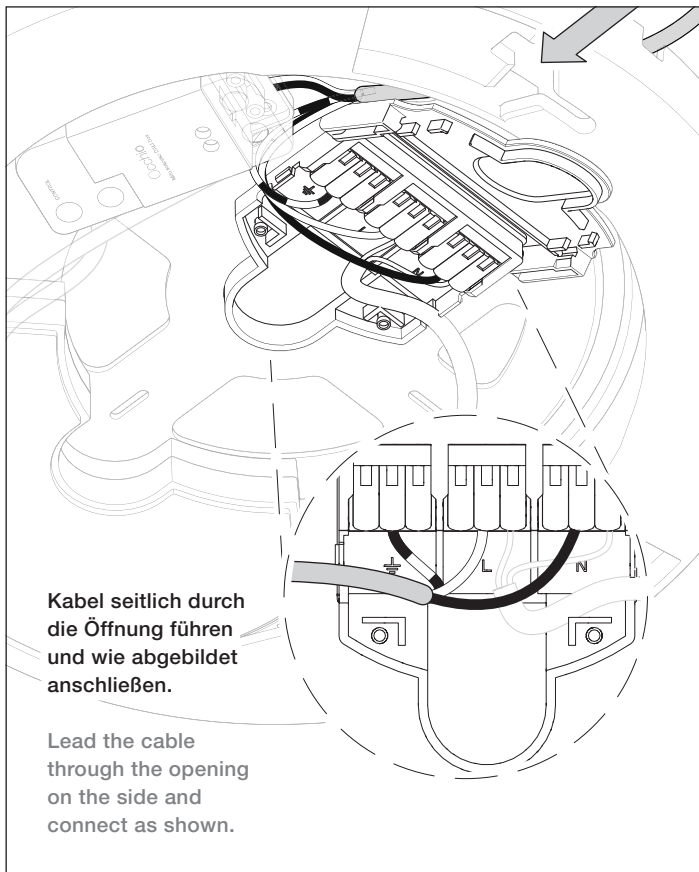
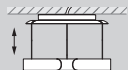

Montage DALI / Mounting DALI

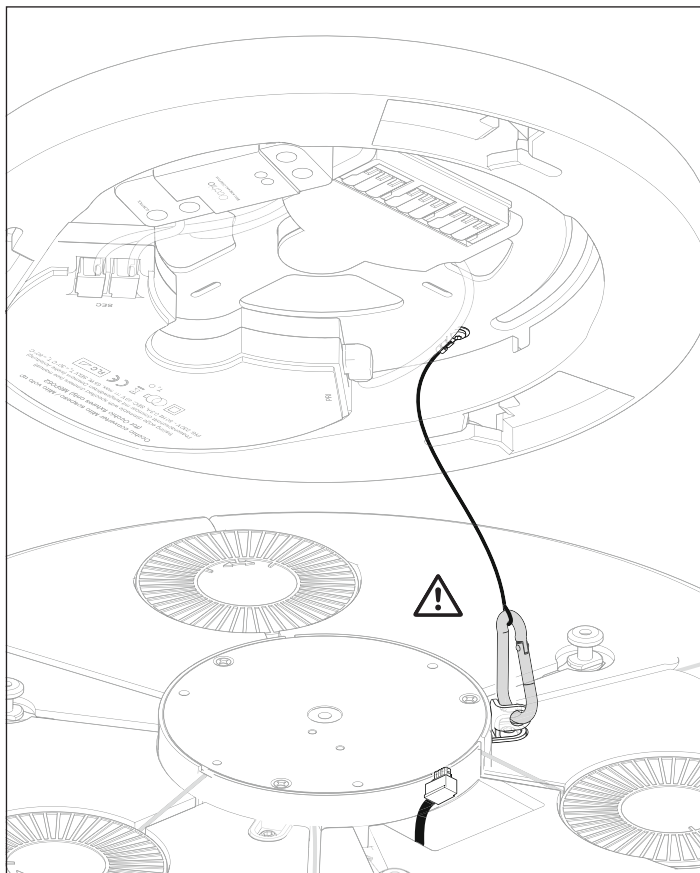

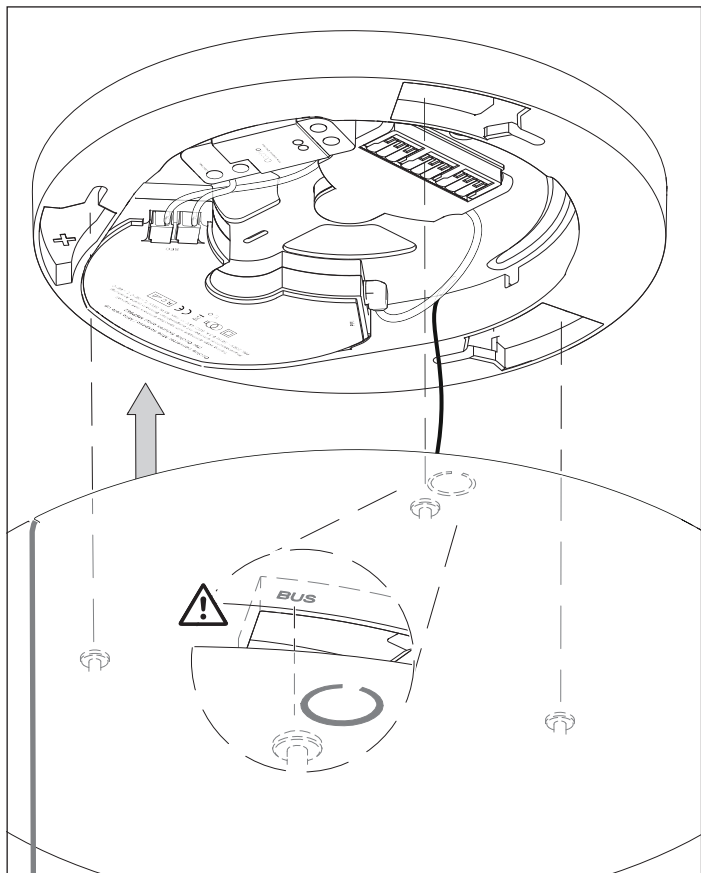
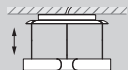

Montage DALI / Mounting DALI

**Baldachin drehen, bis
dieser hörbar einrastet
und Markierung prüfen!**

Turn canopy until you
hear it click into place
and check sign!

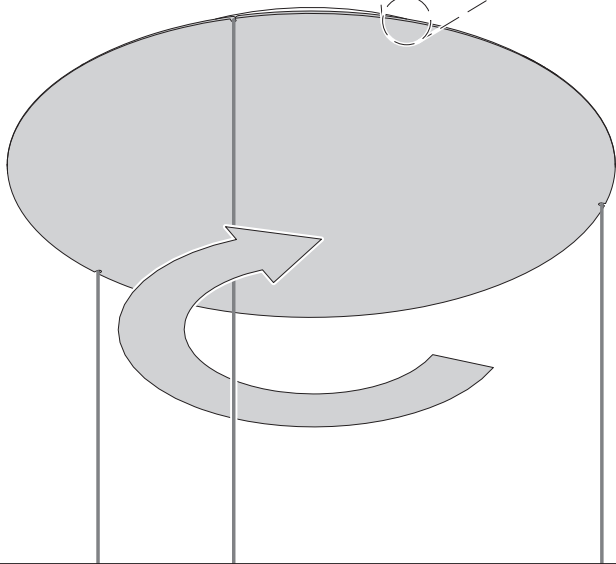
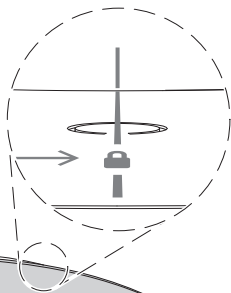

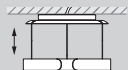

Feinjustierung
fine adjustment

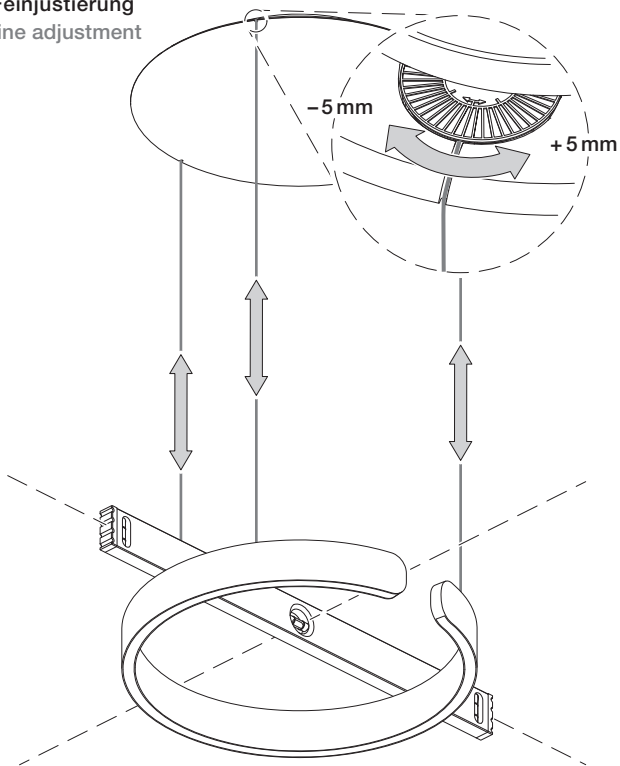

Montage DALI / Mounting DALI

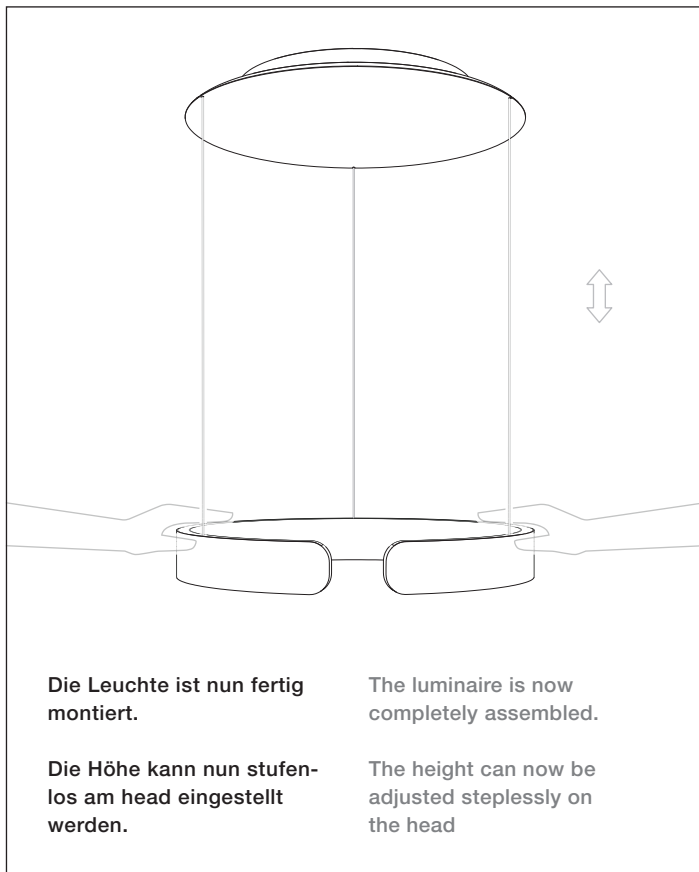

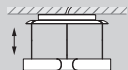

Steuerung mit
der Occhio air
App (optional)

Control using
the Occhio air
app (optional)

Steuerung mit der Occhio air App (optional)

Control using the Occhio air app (optional)

Quick guide

Die Occhio air Produkte lassen sich mit der Occhio air App einrichten und steuern.

App installieren, App öffnen und angeschlossene Leuchten einrichten.

Occhio air products can be set up and controlled using the Occhio air app.

Install App, open App and set up connected luminaires.



Occhio air tutorials

www.occhio.com/air-tutorials

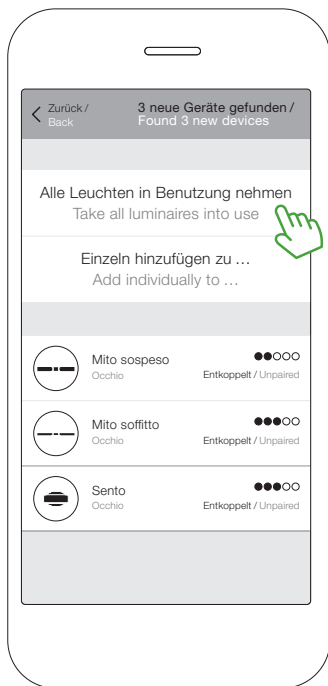

Ein Netzwerk (mein Netzwerk) wird autom. erstellt.

A network (my network) is autom. created.

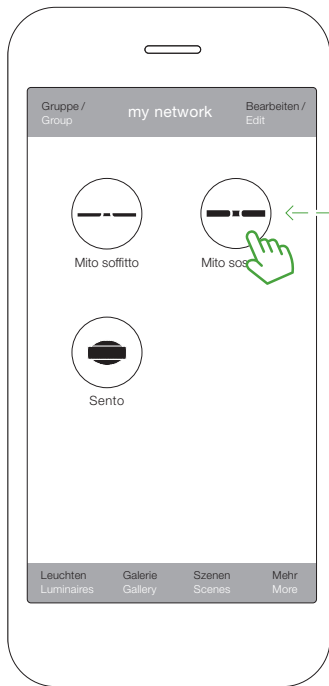

Steuerungsgesten Control gestures

on / off
on / off



antippen
tap

dimmen
dim



wischen
swipe

up / down
faden *



wischen
swipe

color tune **
magic move ***



halten
hold



wischen
swipe

Nur bei Leuchten mit beidseitigem Lichtaustritt *,
color tune ** oder magic move ***

Only for luminaires with double-sided light output *,
color tune ** or magic move ***

Und so werden die Leuchten gesteuert.
And so the luminaires are controlled.

Steuerung mit der Occhio air App (optional) Control using the Occhio air app (optional)

Nutzung auf mehreren Geräten

Use on several devices

Optional können Sie nun ihr
erstelltes Netzwerk (mein
Netzwerk) mit Anderen teilen.

Optionally, you can now share
your created network (my
network) with others.

1. Netzwerknamen
vergeben

1. Assign name

Occhio air tutorials

www.occhio.com/air-tutorials

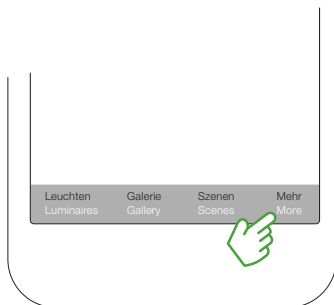

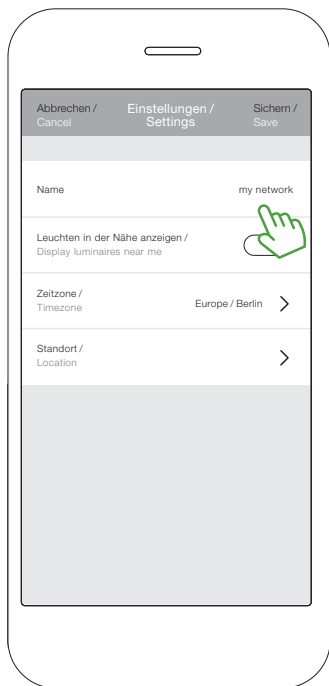

Netzwerkconfiguration → Netzwerkeinstellungen → Namen eingeben → Sichern
Network setup → Network settings → enter name → save

Steuerung mit der Occhio air App (optional) Control using the Occhio air app (optional)

Netzwerk freigeben und schützen

Share and protect the
network

Occhio air tutorials

www.occhio.com/air-tutorials

2. Netzwerk freigeben
2. Share network

Leuchten Luminaires	Galerie Gallery	Szenen Scenes	Mehr More
------------------------	--------------------	------------------	--------------



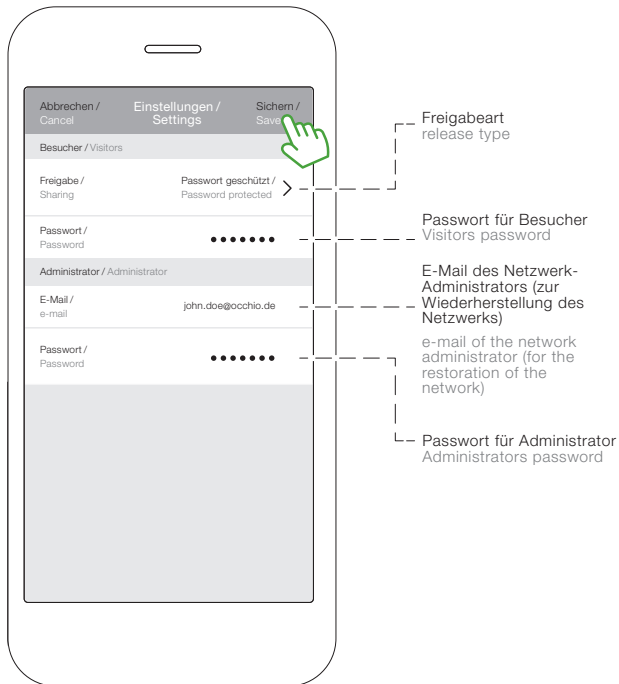

Netzwerkconfiguration → Freigabeoptionen → Passwort geschützt → Sichern
 Network setup → Sharing settings → Password protected → save

Steuerung mit
dem Occhio air
controller
(optional)

Control using
the Occhio air
controller
(optional)

Steuerung mit dem Occhio air controller (optional)

Control using the Occhio air controller (optional)

Occhio air controller

Intuitiv bedienbare Fernbedienung mit vier programmierbaren Tasten (Einrichtung via Occhio air App). Unabhängig von der App können einzelne Leuchten, Gruppen und Szenen gesteuert werden. Optional mit Wandhalterung erhältlich.

Maximaler Bedienkomfort und umfassende Steuerung via Bluetooth 4.0 (Bluetooth Low Energy). Schalten, dimmen, faden, color tune von einzelnen Leuchten, Gruppen und Szenen.

Occhio air controller

Intuitive remote control with four programmable buttons (setup via Occhio air app). Individual luminaires, groups and scenes can be controlled regardless of the app. Available with optional wall mount.

Maximum ease of use and total control via Bluetooth 4.0 (Bluetooth low energy). Switching, dimming, fading, color tune of individual luminaires, groups and scenes.



Zum Einrichten des Occhio air controllers wird die Occhio air App benötigt. Eine Video-Kurzanleitung kann unter: www.occhio.com/air-tutorials aufgerufen werden.

To set up the Occhio air controller, the Occhio air app is required. A video quick start guide can be called up at www.occhio.com/air-tutorials.

schalten/switch



⏏ - ☰ einzelne Leuchten, Gruppen, oder Szenen schalten

⏏ - ☰ switch individual luminaires, groups or scenes

dimmen/dim



⊕ - ☰ einzelne Leuchten, Gruppen, oder Szenen dimmen

⊕ - ☰ dims individual luminaires, groups or scenes

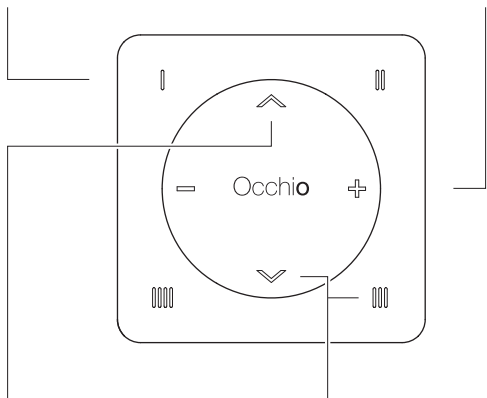

faden*



^ v einzelne Leuchten, Gruppen oder Szenen faden (up/down Verhältnis ändern)

^ v fades individual luminaires, groups or scenes (change up/down relation)

color tune**

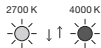

⏏ - ☰ and ^ v Farbtemperatur einzelner Leuchten, Gruppen oder Szenen einstellen

⏏ - ☰ and ^ v adjust color temperature of individual luminaires, groups or scenes

* Leuchten mit beidseitigem Lichtaustritt / luminaires with light emission on both sides ** Mito

Anhang

Appendix

Pflegehinweise

Care instructions

Leuchte nur in abgekühltem Zustand reinigen! Zur Reinigung der Leuchte ein trockenes Mikrofasertuch verwenden. Detaillierte Pflegehinweise sind unter www.occhio.com/de/company/faq zu finden.

Always allow the luminaire to cool down before cleaning! To clean the luminaire, use a dry microfibre cloth. Detailed care instructions are available at www.occhio.com/en/company/faq.

Info & Kontakt

Information & contact





Weitere Fragen beantwortet gerne
Ihr Occhio Fachhändler

Your Occhio specialist retailer will
gladly answer any other questions

www.occhio.com
info@occhio.com

Technische Daten

Technische Daten Leuchte

Artikelbezeichnung	Mito sospeso 40 var up, Mito sospeso 60 var up
Abmessungen	Mito sospeso 40: head ø 400, H 52 mm, Baldachin ø 380 mm, H 39,5 mm Mito sospeso 60: head ø 600, H 52 mm, Baldachin ø 576 mm, H 39,5 mm
Höhenverstellung	Mito sospeso var up: 500 – 2000 mm (variabel)
Schutzklasse	2
Anschluss	230 V AC
Dimmung	via »touchless control«, Occhio air, DALI oder via Phasenabschnittdimmer (Liste kompatibler Dimmer: www.occhio.com/dim , Phasenabschnittdimmer nicht kombinierbar mit »touchless control«, Occhio air oder DALI)
Material	Aluminium, Stahl, lackiert, PVD-be- schichtet, Kunststoff, optischer Silikon, Fiberglas
LED-Leistung	Mito sospeso 40: 40 W Mito sospeso 60: 60 W
Zulässige Betriebsbedingung	max. 30°C nur im Innenbereich betreiben
Prüfzeichen	IP 20 CE    



Technische Daten Leuchtmittel







Leuchtmittel	Occhio »color tune« LED
Ausführung	LED-board
Lebensdauer	> 50.000 Std.

Entsorgung

Bei örtlicher Entsorgungsstelle entsorgen. Mito sospeso var up ist recyclebar; RoHS-konform. **Nicht in den Hausmüll geben!**

Technical data

Technical data luminaire

Product designation	Mito sospeso 40 var up, Mito sospeso 60 var up
Dimensions	Mito sospeso 40: head ø 400, H 52 mm, canopy ø 380 mm, H 39,5 mm Mito sospeso 60: head ø 600, H 52 mm, canopy ø 576 mm, H 39,5 mm
Height adjustment	Mito sospeso var up: 500 – 2000 mm (variable)
Safety class	2
Connection	230 V AC
Dimming	via »touchless control«, Occhio air, DALI or via trailing-edge phasecut dimmer (for a list of compatible dimmers, see www.occhio.com/dim_en , trailing-edge phasecut dimmer can not be combined with »touchless control«, Occhio air or DALI)
Material	Aluminium, painted, PVD-coated steel, plastic, optical silicone, fibreglass
LED power	Mito sospeso 40: 40 W Mito sospeso 60: 60 W
Permitted operating conditions	max. 30°C for indoor use only
Test symbols	IP 20      



Technical data light source

Light source	Occhio »color tune« LED
Version	LED-board
Lifetime	> 50.000 h

Disposal

Dispose of at a local disposal site. Mito sospeso var up is recyclable and RoHS compliant. **Do not dispose of with the household waste!**

Occhio

www.occhio.com



010405944517106210