

GEBRAUCHSANLEITUNG

D



SILVA 160 G9 ALL-IN

ART.-NO. 710 170 710 174
710 171 710 175
710 172 710 176
710 173

TECHNISCHE DATEN

Spannung: 230/240 VAC
Belastung: max. 48 W

Schutzklasse:



Dimmbar:
bruck.de/de/faq/bruck



ALLGEMEINE SICHERHEITSHINWEISE



- Bei allen durchzuführenden Arbeiten an den Produkten (Montage, Wartung, Reinigung) Spannungsversorgung abschalten.
- Die Produkte sind nur für IP 20 Bereiche zugelassen.
- Vorsicht! Produkte (auch LED) können im Betrieb heiß werden.
- Den angegebenen Mindestabstand der Lichtquelle zu brennbaren Gegenständen beachten*
- Wir behalten uns vor, jederzeit Änderungen an den Produkten vorzunehmen! Aktuelle Daten finden sie jederzeit unter www.bruck.de
- Bei eigenmächtigen Veränderungen oder unsachgemäßer Benutzung erlischt jeglicher Anspruch auf Gewährleistung.



LIEFERUMFANG
1 LEUCHTE



MONTAGE: VORBEREITUNG RICHTIG / MOUNTING: PREPARATION CORRECT / MONTAGE: PRÉPARATION CORRECTE
MONTAJE: PREPARAZIONE CORRECTO / MONTAGGIO: PREPARACIÓN CORRECTO



VOLLSTÄNDIG
COMPLETE
COMPLET
COMPLETO
COMPLETO

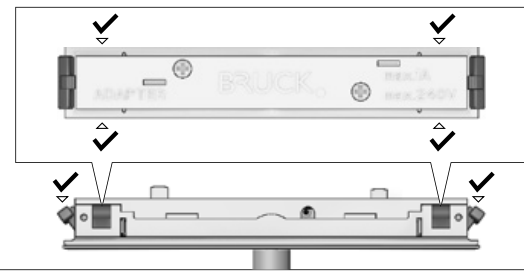

VOLLSTÄNDIG
COMPLETE
COMPLET
COMPLETO
COMPLETO

MONTAGE: VORBEREITUNG FALSCH / MOUNTING: PREPARATION WRONG / MONTAGE: PRÉPARATION INCORRECTE
MONTAJE: PREPARAZIONE INCORRECTO / MONTAGGIO: PREPARACIÓN INCORRECTO



UNVOLLSTÄNDIG
INCOMPLETE
INCOMPLET
INCOMPLETO
INCOMPLETO

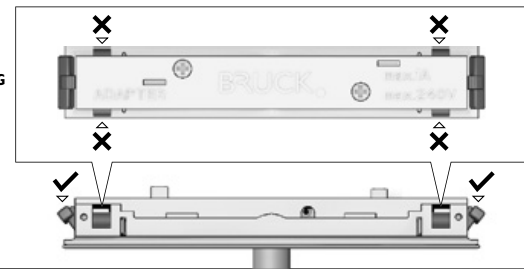

UNVOLLSTÄNDIG
INCOMPLETE
INCOMPLET
INCOMPLETO
INCOMPLETO

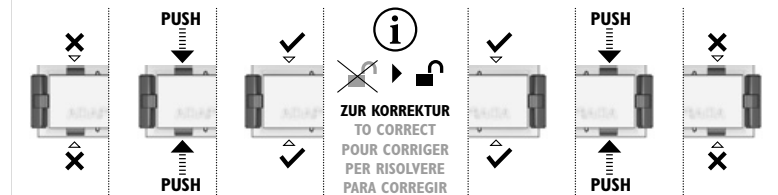

ZUR KORREKTUR
TO CORRECT
POUR CORRIGER
PER RISOLVERE
PARA CORREGIR

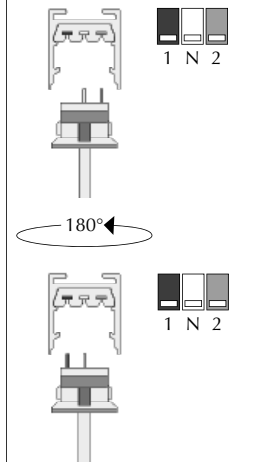
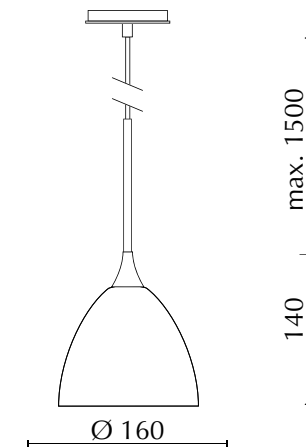

1 N 2

1 N 2

INSTRUCTION MANUAL

GB

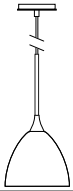

SILVA 160 G9 ALL-IN

ART.-NO.	710 170	710 174
	710 171	710 175
	710 172	710 176
	710 173	

TECHNICAL DATA

Voltage: 230/240 VAC
Load: max. 48 W

Protection class:



Dimmable:
bruck.co.uk/en/faq/dimmer-recommendation/



GENERAL REMARKS ON SAFETY



- For all work to be carried out on the products (assembly, maintenance, repair, cleaning, etc.) switch off the power supply.
- The products are only approved for IP 20 areas.
- Caution! Products (also LED) can become hot during operation.
- Observe the specified minimum distance of the light source to flammable objects *
- We reserve the right to make changes to the products at any time! Current data can be found at www.bruck.de
- With arbitrary changes or improper use any warranty claim expires.



DELIVERY SCOPE:
I LUMINAIRE



MODE D'EMPLOI

F



SILVA 160 G9 ALL-IN

REF.	710 170	710 174
	710 171	710 175
	710 172	710 176
	710 173	

CARACTERISTIQUES TECHNIQUES

Voltage: 230/240 VAC
Wattage: max. 48 W

Classe de protection:



Gradable:
bruckclairage.fr/fr/faq/recommandation-du-gradateur/



CONSIGNES DE SECURITE GENERALES



- Pour tous les travaux à effectuer sur les produits (montage, entretien, réparation, nettoyage, etc.) il faut couper l'alimentation électrique.
- Les produits ne sont homologués que pour les zones IP 20.
- Attention! Les produits (également LED) peuvent devenir chauds pendant le fonctionnement.
- Respecter la distance minimale spécifiée entre la source lumineuse et les objets inflammables *
- Nous nous réservons le droit d'apporter des modifications aux produits à tout moment ! Les données actuelles peuvent être consultées à tout moment sur www.bruck.de
- En cas de modifications arbitraires ou d'utilisation incorrecte, la garantie expire.



VOLUME DE LIVRAISON:
I LUMINAIRE



INSTRUCCIONES DE EMPLEO

E

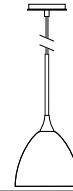

SILVA 160 G9 ALL-IN

REF.	710 170	710 174
	710 171	710 175
	710 172	710 176
	710 173	

DATOS TECNICOS

Voltaje: 230/240 VAC
Carga: max. 48 W

Clase de protección:



Regulable:
bruck.com.es/es/faq/recomendacion-de-atenuacion/



INDICACIONES GENERALES DE SEGURIDAD



- Para todos los trabajos a realizar en los productos (montaje, mantenimiento, reparación, limpieza, etc.) hay que desconectar la alimentación eléctrica.
- Los productos sólo están aprobados para áreas IP 20.
- Precaución! Los productos (también LED) pueden calentarse durante el funcionamiento.
- Observar la distancia mínima especificada entre la fuente de luz y los objetos inflamables *
- Nos reservamos el derecho de hacer cambios en los productos en cualquier momento! Los datos actuales se pueden encontrar en www.bruck.de.
- Con cambios arbitrarios o uso indebido caduca cualquier reclamo de garantía.



VOLUMEN DE ENTREGA:
I LAMPARA



ISTRUZIONI PER L'USO

I

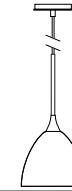

SILVA 160 G9 ALL-IN

COD.	710 170	710 174
	710 171	710 175
	710 172	710 176
	710 173	

DATI TECNICI

Tensione: 230/240 VAC
Wattaggio di lampada: max. 48 W

Tipo di protezione:



Dimmerabile:
bruck.co.it/it/faq/raccomandazione-varialuce/



AVVERTENZE GENERALI PER LA SICUREZZA



- Per tutti i lavori da eseguire sui prodotti (montaggio, manutenzione, riparazione, pulizia ecc.) spegnere l'alimentazione elettrica.
- I prodotti sono approvati solo per ambienti IP 20.
- Attenzione! I prodotti (anche i LED) possono riscaldarsi in funzione.
- Rispettare la distanza minima specificata della sorgente luminosa dagli oggetti che sono infiammabili *
- Ci riserviamo il diritto di apportare modifiche ai prodotti in qualsiasi momento! I dati attuali possono essere trovati in qualsiasi momento all'indirizzo www.Bruck.de
- In caso di modifiche non autorizzate o di uso improprio, tutti i diritti di garanzia scadano.



VOLUME DELLA FORNITURA:
I LAMPADA



1.

Kabel muss vor der Montage durch das Mittelloch des Adapters geführt werden.

Before mounting, the cable must be routed through the middle hole of the adapter.

Avant le montage, le câble doit être passé par le trou au milieu de l'adaptateur.

Antes del montaje el cable tiene que ser pa-sado por el agujero mediano del adaptadores.

Prima del montaggio, il cavo deve essere instradato attraverso il foro centrale del baldacchino.

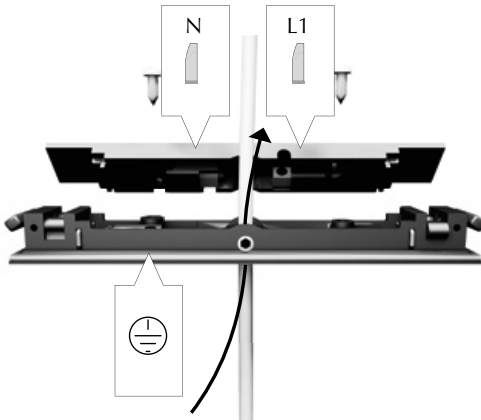

Zunächst Zugentlastung lösen! (2x M4)

First release the strain relief! (2x M4)

Commencez par desserrer le serre-fils! (2x M4)

¡Primer alfoja el alivio de tensión! (2x M4)

Per prima cosa, allentare lo scarico della trazione! (2x M4)



Nach dem Einfädeln wieder fixieren! (2x M4)

Fix again after threading! (2x M4)

Réparez encore après l'enfilage! (2x M4)

¡Arreglar de nuevo después de enhebrar! (2x M4)

Fissare di nuovo dopo la filettatura! (2x M4)

+ 22mm

Gewünschte Länge / Desired length / Longueur désirée / Lunghezza desiderata

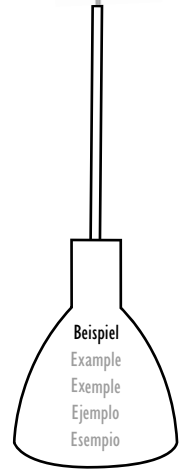
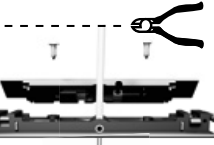

Info

EINZELNE LEITUNGSSCHICHTEN:

- a) transparente Isolationsschicht
- b) transparente Isolationsschicht
- c) äußere Ader (Koaxialgeflecht)
- d) transparente Isolationsschicht
- e) transparente Isolationsschicht
- f) innere Ader

SEPARATE CABLE LAYERS:

- a) transparent isolation layer
- b) transparent isolation layer
- c) outer wire (coaxial gauze)
- d) transparent isolation layer
- e) transparent isolation layer
- f) inner wire

COUCHES DE CÂBLE SÉPARÉES:

- a) couche d'isolation transparente
- b) couche d'isolation transparente
- c) conducteur extérieur (lacs coaxial)
- d) couche d'isolation transparente
- e) couche d'isolation transparente
- f) conducteur intérieur

CAPAS DE CABLE SEPARADAS:

- a) capa de aislamiento transparente
- b) capa de aislamiento transparente
- c) hilo exterior (enrejado coaxial)
- d) capa de aislamiento transparente
- e) capa de aislamiento transparente
- f) hilo interior

STRATI DI CAVI SEPARATI:

- a) Strati isolante trasparente
- b) Strati isolante trasparente
- c) Cavo tessuto esterno
- d) Strati isolante trasparente
- e) Strati isolante trasparente
- f) Cavo interiore

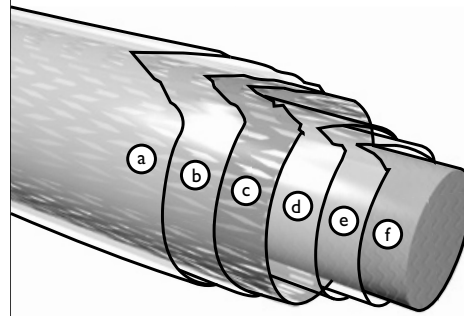

2.

Schnitt setzen gemäß Markierung und Schichten a) b) an der Stelle entfernen.

Cut according to the mark and remove carefully the layers a) and b)

Couper conformément au marquage et y enlever prudemment les couches a) et b)

Cortar según la marca y remover ahí cuidadosamente las capas a) y b)

Tagliate secondo il segno e rimuovete con cura gli strati a) e b)

50mm

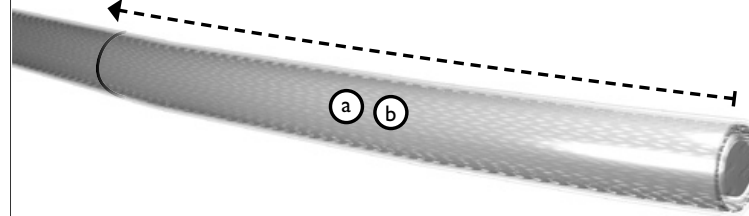

3.

Lösen Sie vorsichtig das Koaxialgewebe bis zur markierten Stelle c)...

Loosen carefully the coaxial gauze c) until the mark...

Enlever prudemment le lacs coaxial c) jusqu'au marquage...

Despegar cuidadosamente el enrejado coaxial c) hasta la marca...

Scollare prudenente i strati tessuti fino al segno c)...

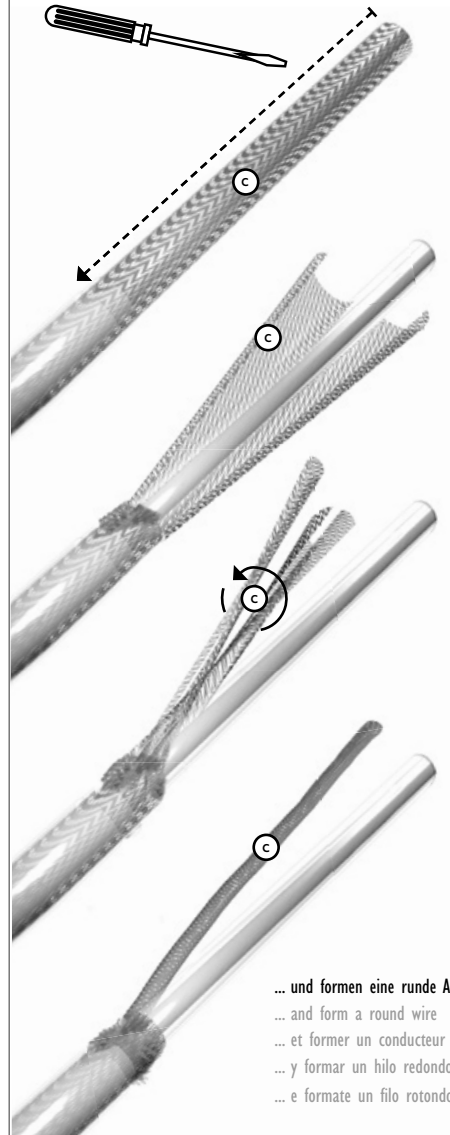

... und formen eine runde Ader daraus.

... and form a round wire

... et former un conducteur rond

... y formar un hilo redondo

... e formate un filo rotondo

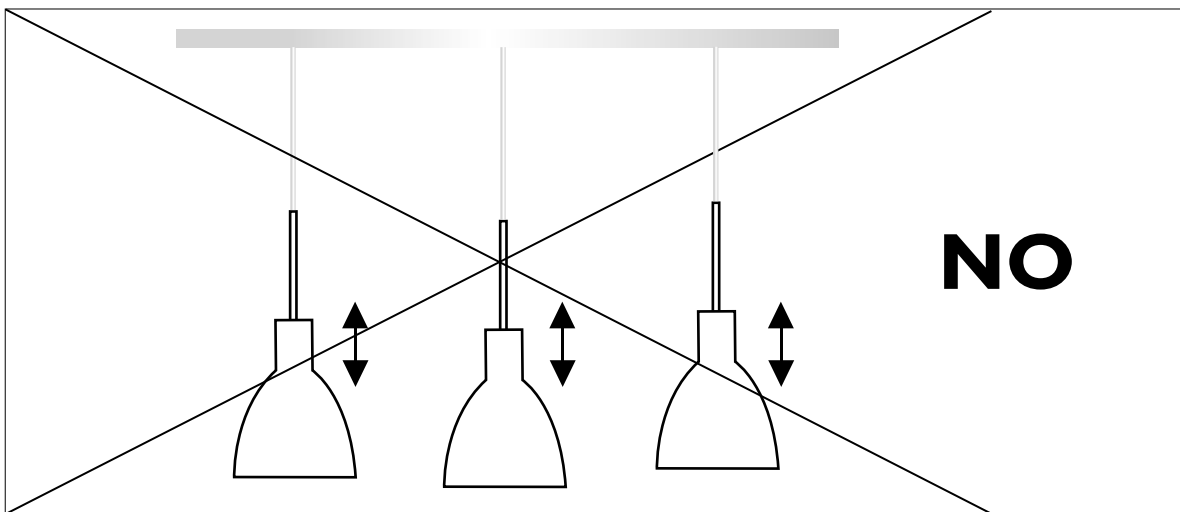
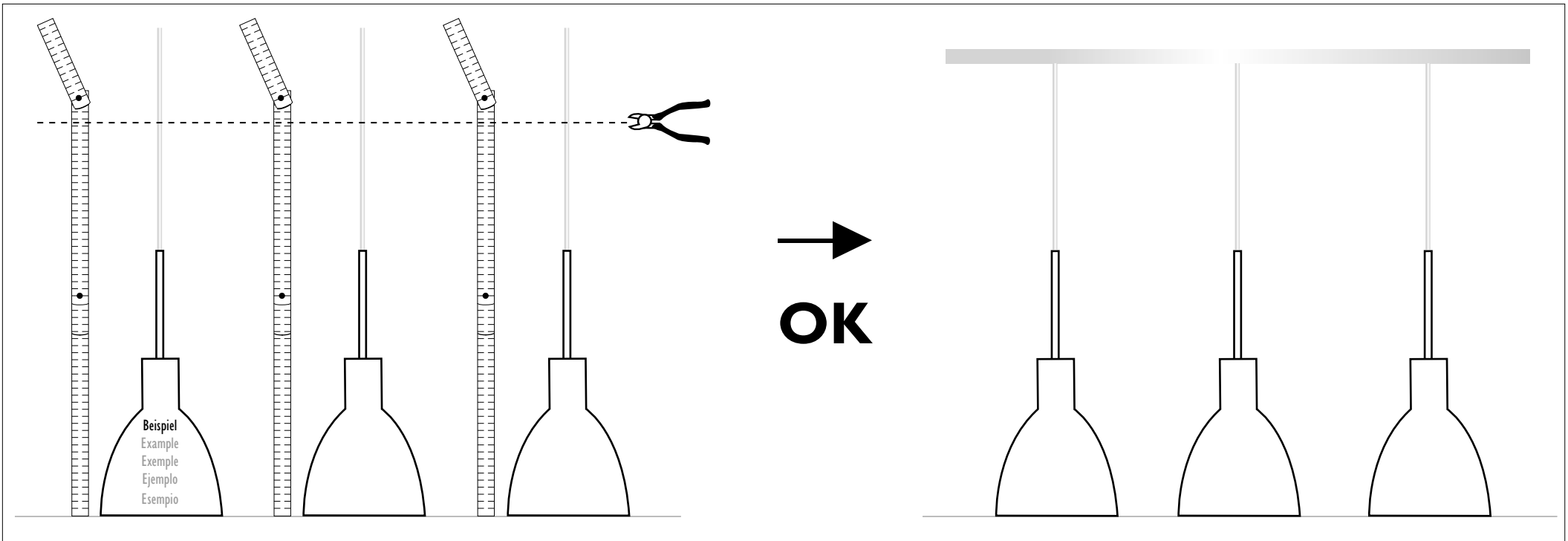

ACHTUNG! ATTENTION! ATTENTION! ¡ATENCIÓN! ATENZIONE!

Alle Kabel auf gleiche Länge kürzen.

Danach ist eine Korrektur der Höhe nicht mehr möglich.

Shorten all cables to the same length.

Height cannot be adjusted afterwards.

Raccourcissez tous les câbles à la même longueur.

Après cela, une correction de la hauteur n'est plus possible.

Accorte todos los cables a la misma longitud.

A partir de entonces, ya no es posible corregir la altura.

Accorciare tutti i cavi alla stessa lunghezza.

Dopo non è più possibile correggere l'altezza.

4.

Setzen Sie eine Markierung (ca 8-10mm) und lösen Sie die Schichten d) und e)...

Set a mark (8-10mm) and loosen the layers d) and e)...

Poser un marquage (8-10mm) et enlever les couches d) et e)...

Poner una marca (8-10mm) y despegar las capas d) y e)...

Impostate un segno /ca.8-10mm) e scollare i strati d) e e)...



...Innenader f) frei zu legen

...to expose inner wire f)

...afin de dénuder le conducteur intérieur f)

...para denudar el hilo interior f)

... Scoprite lo cavo interno f)

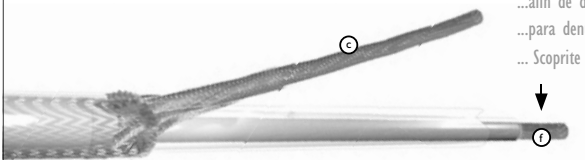

Das veränderte Kabel ist nun bereit für die Wiederherstellung der Schutzisolierung gemäß der Schutzklasse 2.

The modified cable is now prepared for the rebuilding of the protection isolation according to protection class 2.

Le câble modifié est maintenant prêt pour la récupération de l'isolation protectrice conforme à la classe de protection 2.

El cable modificado está preparado ahora para el restablecimiento del aislamiento protector según la clase de protección 2.

Il cavo modificato viene ora preparato per la ricostruzione dell'isolamento di protezione in base alla classe di protezione 2.

Info

Es können keine sicheren Kabelveränderungen durchgeführt werden ohne diese Materialien:

No safe cable modifications can be made without these materials:

On ne peut pas effectuer des modifications sûres de câble sans ces matériaux:

No se puede efectuar modificaciones seguras de cable sin estos materiales:

Nessuna modifica sicura del cavo può essere apportata senza questi materiali:



2 x Aderendhülse

2 x wire end sleeves 2 x embouts

2 x puntas terminales 2 x puntalino

2 x

2 x



4 x Schrumpfschlauch

4 x heat shrink tubes

4 x gaines thermorétractables

4 x tubos termorretráctiles

4 x tubi termoretraibili

5.

! Blanke Kabel sind komplett bedeckt!
Bare cables are covered completely!
Les câbles nus sont complètement couverts!
Los cables nudos están completamente cubiertos!
I cavi nudi sono completamente coperti!

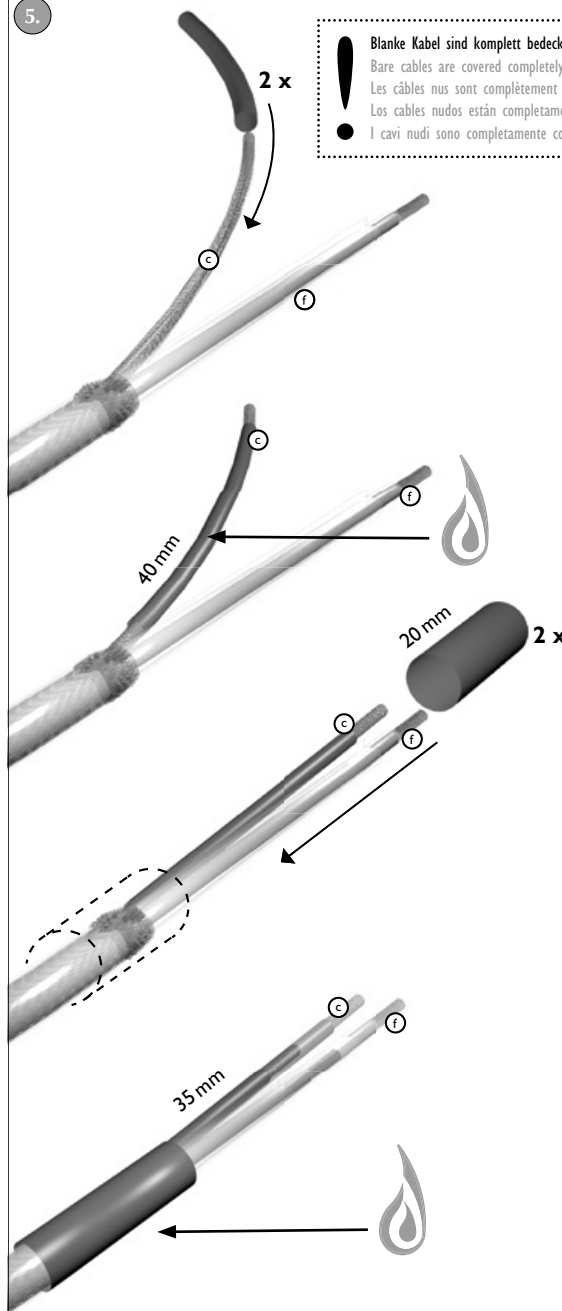

Schieben Sie auf die zusammen gedrehte Koaxialader c) ein Stück des dünnen Schrumpfschlauchs (10mm freilassen für die Aderendhülse!).

Slide a piece of the thin shrink tube on the coaxial wire c) rotated together (Leave 10mm for the ferrule!).

Glisser un morceau du mince tube thermorétractable sur le conducteur coaxial tourné ensemble c) (Laisser 10 mm pour l'embout!).

Deslizar una pieza del tubo termorretráctil delgado en el hilo coaxial (c) girado juntos (¡Dejar 10 mm para la punta terminal!).

Passate sul filo coassiale ruotato c) un pezzo del tubo termoretraibile sottile (Lasciate 10mm per il puntalino!).

Erwärmen Sie den Schrumpfschlauch bis er fest an der Ader anliegt, und wiederholen den Vorgang mit dem 2. Abschnitt des dünnen Schrumpfschlauchs (Schutzklasse 2).

Heat the shrink tube until it is firmly attached to the wire, and repeat the process with the 2nd section of the thin shrink tube (protection class 2).

Chauffer la gaine thermorétractable jusqu'à ce qu'elle soit fermement attaché au fil, et répétez le processus avec la 2ème section du mince gaine thermorétractable (classe de protection 2).

Calentar el tubo retráctil hasta que esté firmemente unido al cable, y repetir el proceso con la segunda sección del tubo retráctil delgado (clase de protección 2).

Riscaldare il tubo termoretraibile finché non è saldamente fissato al filo e ripetete il processo con la seconda sezione del tubo termoretraibile sottile (classe di protezione 2).

Danach den dickeren Schrumpfschlauch über beide Adern auf die Trennstelle des Koaxialgeflechts ziehen und...

Then pull the thicker heat shrink tube over both leads and over the separation point of the coaxial gauze and ...

Ensuite, tirer la gaine thermorétractable plus épaisse sur les deux fils et sur le point de séparation du lacs coaxial et ...

Luego, tirar el tubo termorretráctil más grueso por ambos cables y por el punto de separación del enrejado coaxial y ...

Quindi tirare il tubo termoretraibile più spesso sopra entrambi i fili e sopra il punto di separazione della garza coassiale e ...

Info

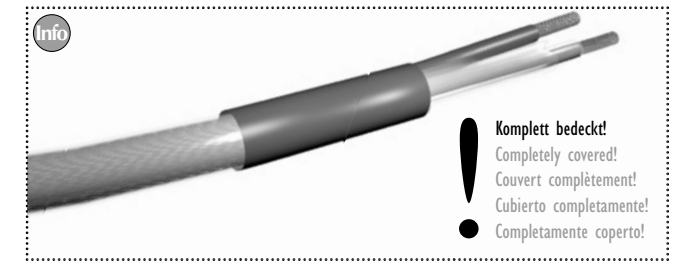

! **Komplett bedeckt!**
Completely covered!
Couvert complètement!
Cubierto completamente!
Completamente coperto!

... erwärmen und ebenso wiederholen um eine 2fache Isolationsschicht an der Stelle zu haben.

... heat up and repeat to have a 2-fold layer of insulation in place.

... chauffer et répéter pour avoir une double couche d'isolation en place.

... calentar y repetir para tener una capa doble de aislamiento en el lugar.

... riscaldare e ripetete per avere un doppio strato di isolamento in posizione.

6.

Positionieren Sie die beiden Aderendhülsen auf den Aderenden c) und f) und verpressen sie diese mit einem entsprechenden Werkzeug.

Mount both wire end sleeves to the wire ends c) and f) and press them with an adequate tool.

Fixer les deux embouts aux extrémités de câble c) et f) et les serrer avec un outil approprié.

Fijar las dos puntas terminales a los terminales del hilo c) y f) y apretar con una herramienta adecuada.

Positionate entrambe le estremità dei fili sui terminali c) e f) e premerle con uno strumento adeguato.

7.

Schließen Sie beide Adern an den vorgesehenen Klemmen an.

Connect both wires to the terminals provided.

Connecter les deux fils aux bornes fournies.

Conectar ambos cables a los terminales provistos.

Collegare entrambi i cavi ai terminali forniti.

0,25 Nm

ADAPTER MONTIEREN / ASSEMBLING THE ADAPTER THE ADAPTER / MONTAGE DE L'ADAPTATEUR
MONTAJE DEL ADAPTADOR / MONTARE L'ADATTATORE

ADAPTER ABMONTIEREN / DISASSEMBLING THE ADAPTER / DEMONTAGE DE L'ADAPTATEUR
DESMONTAJE DEL ADAPTADOR / RIMUOVERE L'ADATTATORE
