

IN THE TUBE

de Dominique Perrault et Gaëlle Lauriot-Prévost

FICHE TECHNIQUE TECHNICAL SHEET

ACCESSOIRES

ACCESSORIES

BOÎTIER DE CONNEXION CONNECTION BOX

Matériaux
Material

Corps: acier inoxydable, silicone
Body: stainless steel, silicon

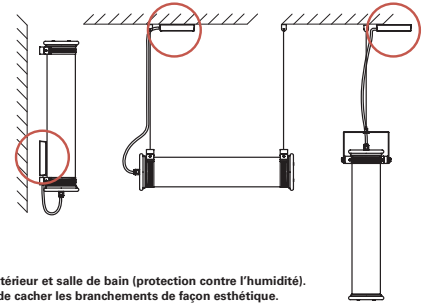
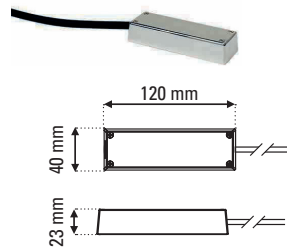

Accessoire indispensable pour un usage du luminaire en extérieur et salle de bain (protection contre l'humidité).
Pour un usage en intérieur, le boîtier de connexion permet de cacher les branchements de façon esthétique.
Essential accessory for an outdoor and bathroom use of the light (protection against moisture).
For an indoor use, the connection box enables to aesthetically hide the wiring.

SUSPENSIONS VERTICALES VERTICAL PENDANTS

Matériaux
Material

Acier inoxydable
Stainless steel

HANG 1 - 100

ITT 100-350 / 100-500

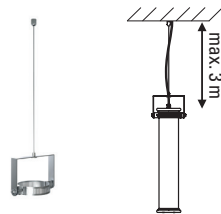

HANG 1 - 120

ITT 120-700 / 120-1300

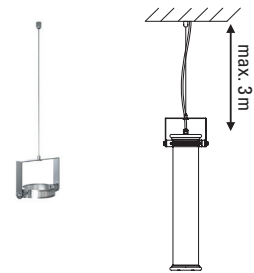

SUSPENSION HORIZONTALE HORIZONTAL PENDANT

Matériaux
Material

Acier inoxydable
Stainless steel

HANG 2

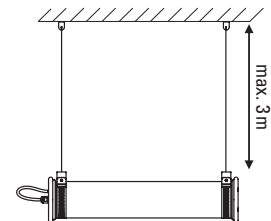

TRAPPE 75 TRAPDOOR 75

Matériaux
Material

Plâtre haute dureté
High density plaster

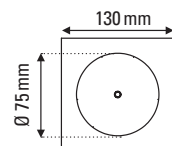

IN THE TUBE

de Dominique Perrault et Gaëlle Lauriot-Prévost

FICHE TECHNIQUE TECHNICAL SHEET

ACCESSOIRES ACCESSORIES

COLLIERS D'ANGLE ANGLE COLLARS

Matériaux **Acier inoxydable**
Material Stainless steel

ITT ANGLE 1 - 100



ITT ANGLE 1 - 120



COLLIERS INCLINÉS SLANTED COLLARS

Matériaux **Acier inoxydable**
Material Stainless steel

DIAG 1 - 100

ITT 100-350 / 100-500

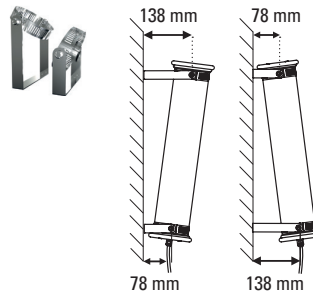

DIAG 1 - 120

ITT 120-700 / 120-1300

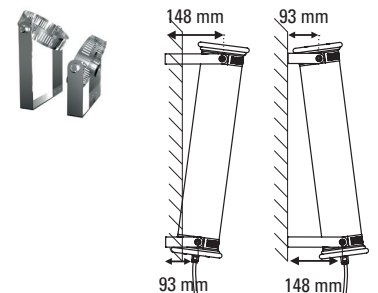

PLAQUE D'ORNEMENT ACIER INOX ORNAMENTAL STAINLESS STEEL PLATE

Matériaux **Acier inoxydable**
Material Stainless steel

COVER PLATE

