

# Occhio

## Mito aura

Montageanleitung  
Mounting instructions

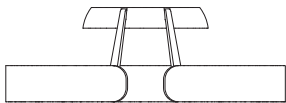

+ DALI



# Inhalt / Contents

Sicherheitshinweise	04	Safety precautions	05
Produktbeschreibung	06	Product description	07
<b>Schritt 1</b>		<b>Step 1</b>	
<b>Steuerung</b>	<b>09</b>	<b>Control</b>	<b>09</b>
Mito set box (standard)	11	Mito set box (standard)	11
Mito »air« box (optional)	21	Mito »air« box (optional)	21
Mito DALI box (optional)	29	Mito DALI box (optional)	29
<b>Schritt 2</b>		<b>Step 2</b>	
<b>Montage</b>	<b>35</b>	<b>Mounting</b>	<b>35</b>
Steuerung mit der Occhio air App (optional)	55	Control using the Occhio air app (optional)	55
Steuerung mit dem Occhio air controller (optional)	63	Control using the Occhio air controller (optional)	63
Anhang	67	Appendix	67
Pflegehinweise	68	Care instructions	68
Info & Kontakt	69	Information & contact	69
Technische Daten	70	Technical data	72

# Sicherheitshinweise

Lesen Sie die Montage-/Gebrauchsanweisung sorgfältig durch, bevor Sie die Leuchte installieren. Beachten Sie die Sicherheitshinweise in dieser Anleitung genau und bewahren Sie die Anleitung auf.



Dieses Zeichen macht Sie auf eine gefährliche Situation aufmerksam, die eine schwere Verletzung oder den Tod nach sich ziehen kann, wenn sie nicht beachtet wird. Es macht Sie zudem auf mögliche Sachschäden und andere wichtige Informationen in Verbindung mit diesem Produkt aufmerksam.



Die Montage von Elektrokomponenten darf nur von qualifiziertem Fachpersonal durchgeführt werden. Reparaturarbeiten dürfen nur von autorisiertem Fachpersonal oder dem Hersteller durchgeführt werden. Vor allen Arbeiten an der Leuchte (Installation, Reinigung etc.) diese unbedingt vom Stromnetz trennen.



Dieses Zeichen macht Sie auf Situationen aufmerksam, bei denen Sie direkt in das Licht der LED blicken könnten. Dies kann zu Nachbildern und bei längerer Dauer zu Schädigungen der Augen führen.



Sicherheitsabstand zu brennbaren Objekten einhalten: 20 cm!



Dieses Zeichen macht Sie auf heiße Oberflächen aufmerksam, deren Berührung Verbrennungen zur Folge haben können.

Achtung: Die Oberfläche der Leuchte kann nach längerer Betriebsdauer heiß sein! Vor allen Arbeiten an der Leuchte (Montage usw.), Leuchte immer ausschalten und mindestens 30 Minuten abkühlen lassen.

## Safety precautions

Read through the mounting/ use instructions carefully before installing the luminaire. Follow the safety precautions in these instructions closely and keep the instructions in a safe place.



This symbol warns you of a dangerous situation which could lead to serious injury or even death if the instructions are not observed. It also draws your attention to possible material damage and provides other important information in connection with this product.



The assembly and installation of electrical components must be carried out only by qualified personnel. Repairs must be carried out only by authorised, qualified personnel or the manufacturer. Before performing any work on the luminaire (installation, cleaning, etc.), it must be disconnected from the mains supply.



This symbol draws your attention to situations in which you could look directly into the light of the LED. This may cause an after-image effect and may result in damage to the eyes if you look at the light directly for prolonged periods.



Maintain the minimum safety distance from flammable materials: 20 cm.



This symbol warns you of hot surfaces, which could cause burns if touched.

Caution: When used for prolonged periods, the surface of the luminaire can become hot. Before performing any work on the luminaire (fitting the luminaire etc.), always switch the luminaire off and let it cool for at least 30 minutes.

# Produktbeschreibung

Ringförmige LED Decken- und Wandleuchte mit beidseitigem Lichtaustritt und einem Durchmesser von 40 cm / 60 cm. Es stehen zwei Lichtwirkungen zur Wahl. narrow bietet als Deckenleuchte diffuses Licht nach oben und gebündeltes Licht nach unten für eine perfekte Ausleuchtung in jeder Anwendung. wide bietet als Decken- und Wandleuchte diffuses Licht nach oben bzw. hinten zur indirekten Ausleuchtung von Decke / Wand und breit abstrahlendes Licht nach unten bzw. vorne.

Version mit integriertem Vorschaltgerät für Aufputzmontage, Anschluss an 230 V AC Netzspannung. Steuerbar über » touchless control « (Gestensteuerung am head), Occhio air oder DALI, alternativ steuerbar via Phasenabschnittdimmer\*.

Die Farbtemperatur ist stufenlos steuerbar via » touchless control «, Occhio air oder DALI von 2700 – 4000 K oder voreinstellbar (2700 / 3000 / 3500 / 4000 K).

\* Liste kompatibler Dimmer: [www.occhio.com/dim](http://www.occhio.com/dim), Phasenabschnittdimmer, »touchless control«, Occhio air und DALI nicht kombinierbar

## Product description

Ring-shaped ceiling and wall LED luminaires with double-sided light emission and a diameter of 40 cm / 60 cm. The luminaires come with two different lighting effects: as a ceiling luminaire, narrow directs diffuse light upward and concentrated light downward to create perfect illumination for every application. As a ceiling and wall luminaire, wide directs diffuse light upward and backward to indirectly illuminate the ceiling / wall and expansive light downward and forward.

Version with an integrated power supply unit for surface mounting, connection to 230 V AC power supply. Controllable with the help of » touchless control « (gesture control on the head), Occhio air or DALI, or, alternatively, controllable with a trailing-edge phase-cut dimmer. \*

The color temperature is infinitely variable between 2700 and 4000 Kelvin using » touchless control « Occhio air or DALI or with preset values (2700, 3000, 3500 or 4000 Kelvin).

\* For a list of compatible dimmers, see [www.occhio.com/dim\\_en](http://www.occhio.com/dim_en), trailing-edge phase-cut dimmer, » touchless control«, Occhio air and DALI not combinable





# Steuerung

Funktionen / Steuerungsmöglichkeiten der Leuchte einstellen.

# Control

Set functions / control options of the luminaire.

Mito set box (standard)

Seite / page 11

Mito »air« box (optional)

Seite / page 21

Mito DALI box (optional)

Seite / page 29



Mito set box  
(standard)

## Mito set box (standard)

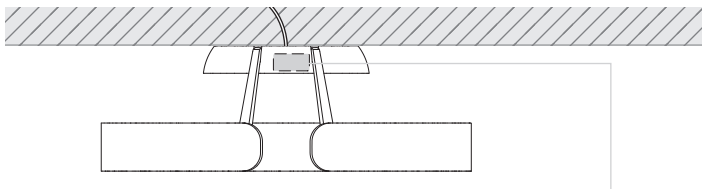



Occhio

COLOR (SENSOR OFF)

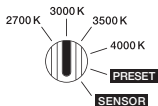

**SENSOR** = »touchless control«\*

Gestensteuerung / gesture control (Seite / page 14)

- schalten / switching
- dimmen / dim
- up / down fading
- color tune

**PRESET** = PRESET\*\*

extern schalten und dimmen / switch and dim externally  
(Seite / page 16)

- up / down Verhältnis einstellbar (5 Stufen)  
up / down relation adjustable (5 stages)
- Farbtemperatur einstellbar (4 Stufen)  
color temperature adjustable (4 stages)

COLOR (SENSOR OFF)

2700 K 3000 K 3500 K 4000 K = **color preset\*\***

Farbtemperatur voreinstellbar, extern schalten und dimmen /  
color temperature pre-settable switch and dim externally  
(Seite / page 18)

- extern schalten und dimmen /  
switch and dim externally

\* **Nicht kombinierbar** mit einem externen  
Phasenabschnittdimmer.

\*\* **Kombinierbar** mit einem externen  
Phasenabschnittdimmer.

\* **Can not be combined** with an external  
trailing-edge phase-cut dimmer.

\*\* **Can be combined** with an external  
trailing-edge phase-cut dimmer.

## » touchless control «

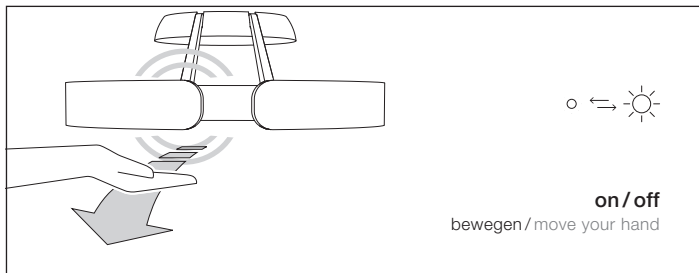

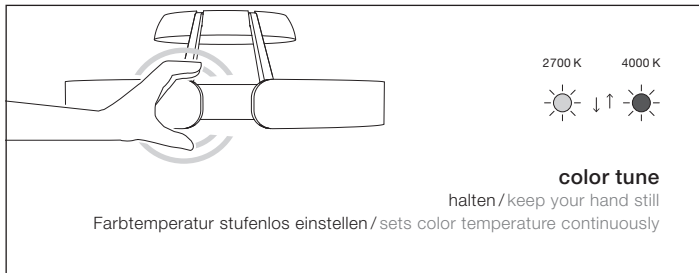
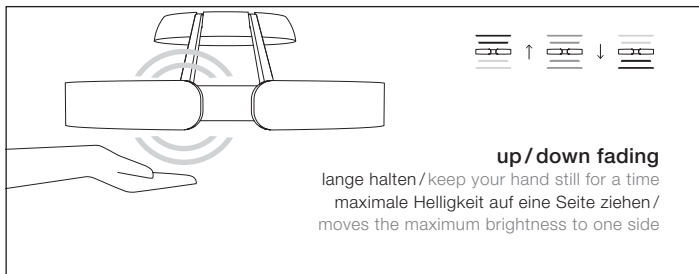
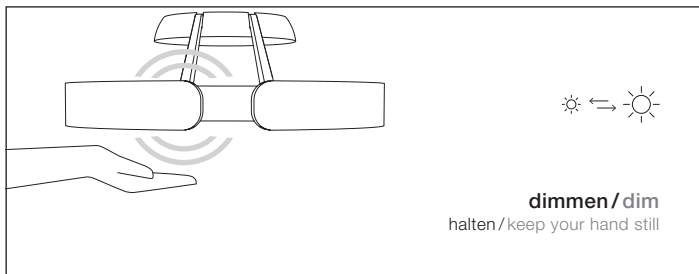

# PRESET (Sensor aus / sensor off)

Die Funktion PRESET ist besonders dann sinnvoll wenn mehrere Leuchten im gleichen Lichtverhältnis und der gleichen Farbtemperatur eingestellt werden sollen. Zusätzlich ist die Leuchte extern schalt- und dimmbar.

The PRESET function is particularly useful when several luminaires are to be set in the same light ratio and the same color temperature. In addition, the luminaire is externally switchable and dimmable.

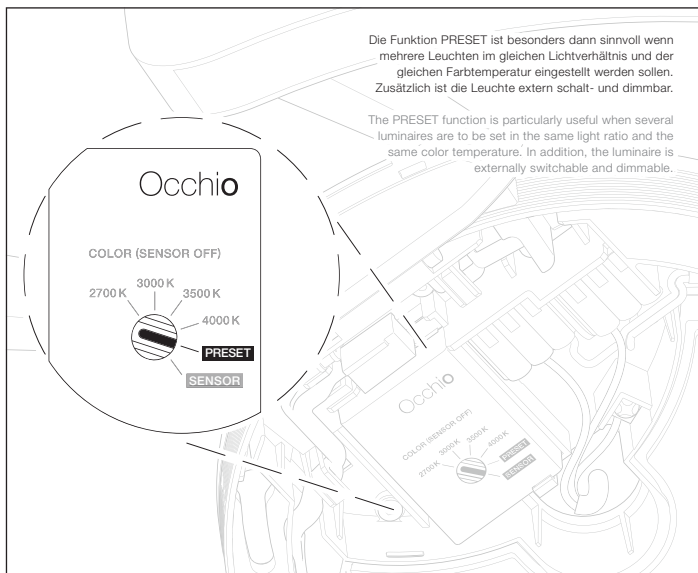



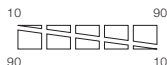
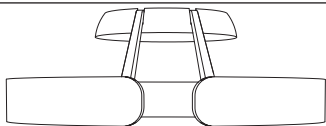

**up/down**

**Verhältnis einstellbar / relation adjustable**

lange halten / keep your hand still for a time

Lichtverhältnis in 5 Stufen einstellen / sets the lighting conditions in 5 stages

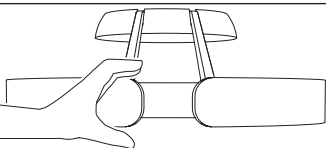

**color tune**

**Farbtemperatur einstellbar / color temperature adjustable**

lange halten / keep your hand still for a time

Farbtemperatur in 4 Stufen einstellen / sets color temperature in 4 stages

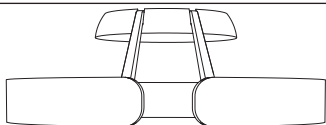

5 Min. warten oder aus- und einschalten / wait for 5 min. or switch off and on

Einstellung ist nun gespeichert / the setting is now saved

phasenabschnittdimmbar / trailing-edge phase-cut dimmable

color preset ( »touchless control« deaktiviert /  
»touchless control« deactivated)

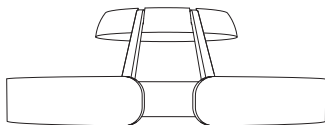
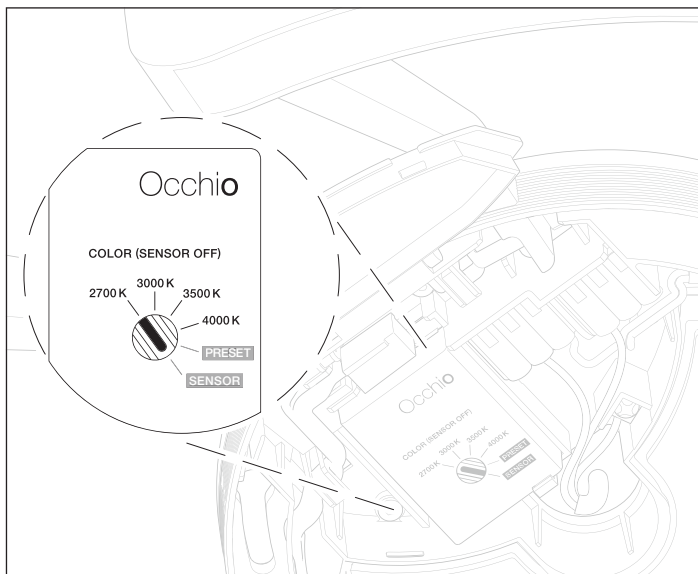

**Farbtemperatur voreinstellbar**  
color temperature pre-settable  
(2700 K, 3000 K, 3500 K, 4000 K)

Lichtverhältnis 50 % up und 50 % down / lighting conditions 50 % up and 50 % down  
»touchless control« **deaktiviert** / »touchless control« **deactivated**  
phasenabschnittdimmbar / trailing-edge phase-cut dimmable





Mito »air« box  
(optional)

## Mito »air« box (optional)

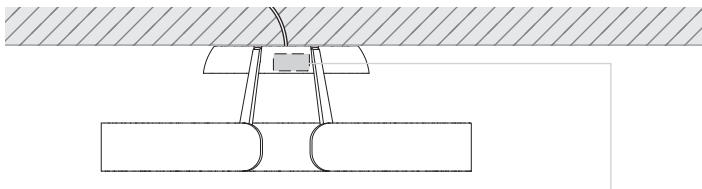

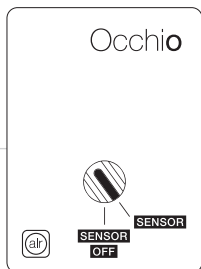

**SENSOR = »touchless control« + »air«**

Bluetooth- und Gestensteuerung / bluetooth and gesture control  
(Seite / page 24)

- schalten / switching
- dimmen / dim
- up / down fading
- color tune

**SENSOR OFF = »air«**

Bluetoothsteuerung / bluetooth control (Seite / page 26)

- schalten / switching
- dimmen / dim
- up / down fading
- color tune

**Nicht kombinierbar** mit einem externen Phasenabschnittdimmer.

**Can not be combined** with an external trailing-edge phase-cut dimmer.

» touchless control « + » air «

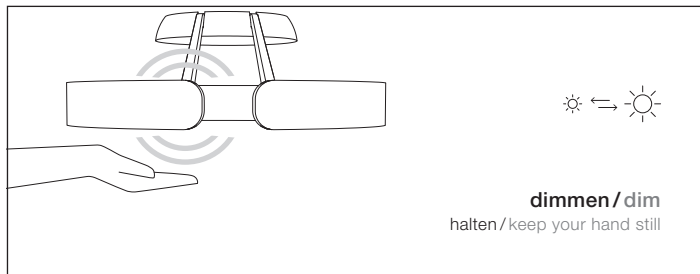
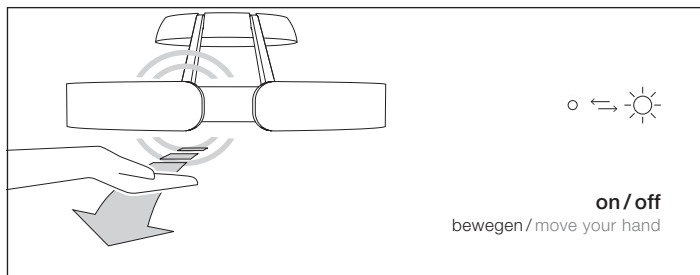
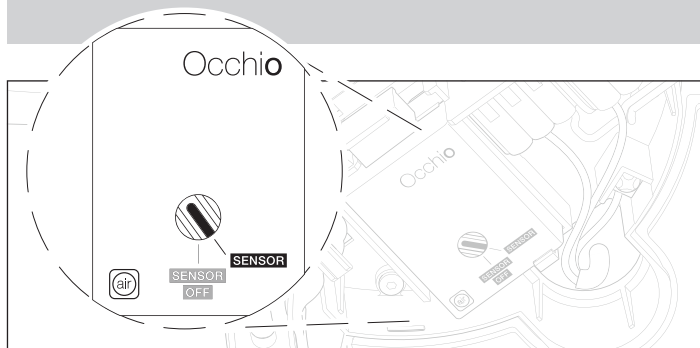



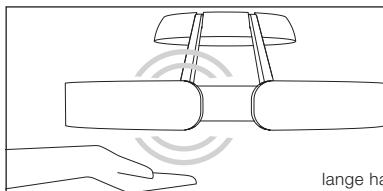

### up/down fading

lange halten / keep your hand still for a time  
maximale Helligkeit auf eine Seite ziehen /  
moves the maximum brightness to one side

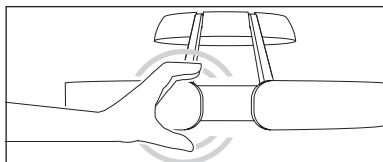

2700 K      4000 K

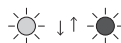

### color tune

halten / keep your hand still  
Farbtemperatur stufenlos einstellen / sets color temperature continuously

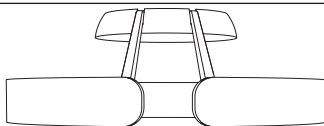

Steuerung via Occhio air, weitere Informationen ab Seite 55.  
Control via Occhio air, for further information see page 55.

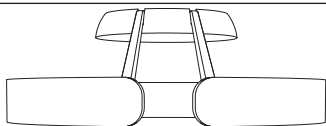
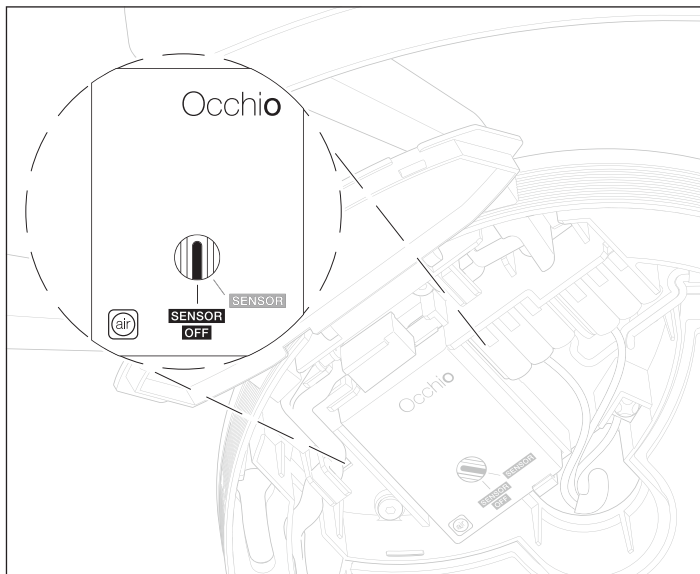

Steuerung via Occhio air, weitere Informationen ab Seite 55.  
Control via Occhio air, for further information see page 55.





Mito DALI box  
(optional)

## Mito DALI box (optional)

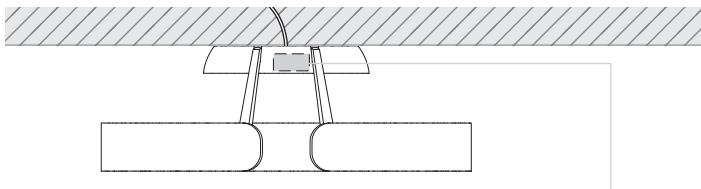



## **DALI**

DALI-Steuerung / DALI control  
(Seite / page 32)

- schalten / switching
- dimmen / dim
- Steuerung von up / down light /  
control up / down light
- color tune

# DALI-Steuerung

## DALI control

Jedem DALI-Strang können max. 32 Mito aura zugeordnet werden.

Die Mito aura benötigt zwei DALI-Adressen je Leuchte, dadurch sind Ober- und Unterseite über eine eigene DALI-Adresse steuerbar. Die max. Leistung wird erreicht wenn beide DALI-Leuchten (Ober- und Unterseite) auf max. Helligkeit eingestellt sind (40 W = 20 W up und 20 W down; 60 W = 30 W up und 30 W down).

Die Mito aura können in bis zu 16 Gruppen organisiert und mit zusätzlich 16 Szenen (vordefinierte Einstellungen) versehen werden.

Über eine DALI-Kurzadresse können sie einzeln angesteuert und eingestellt werden, zusätzlich ermöglicht es der bidirektionale Datenaustausch den Zustand/Status von einzelnen Leuchten abzufragen.

Detaillierte Hinweise sind unter [www.occhio.com/dali](http://www.occhio.com/dali) zu finden.

A maximum of 32 Mito aura units can be assigned to each DALI circuit.

The Mito aura requires two DALI addresses per luminaire, which enables control of the top and bottom sides via their own respective DALI address. The maximum output is reached if both DALI luminaires (top and bottom side) are set to maximum brightness (40 W = 20 W up and 20 W down; 60 W = 30 W up and 30 W down).

The Mito aura units can be organized into as many as 16 groups and equipped with an additional 16 scenarios (predefined settings).

Using a DALI short address, they can be actuated and configured individually. In addition, the bi-directional data transfer lets users query the state/status of individual luminaires.

You can find more detailed information at [www.occhio.com/dali](http://www.occhio.com/dali).



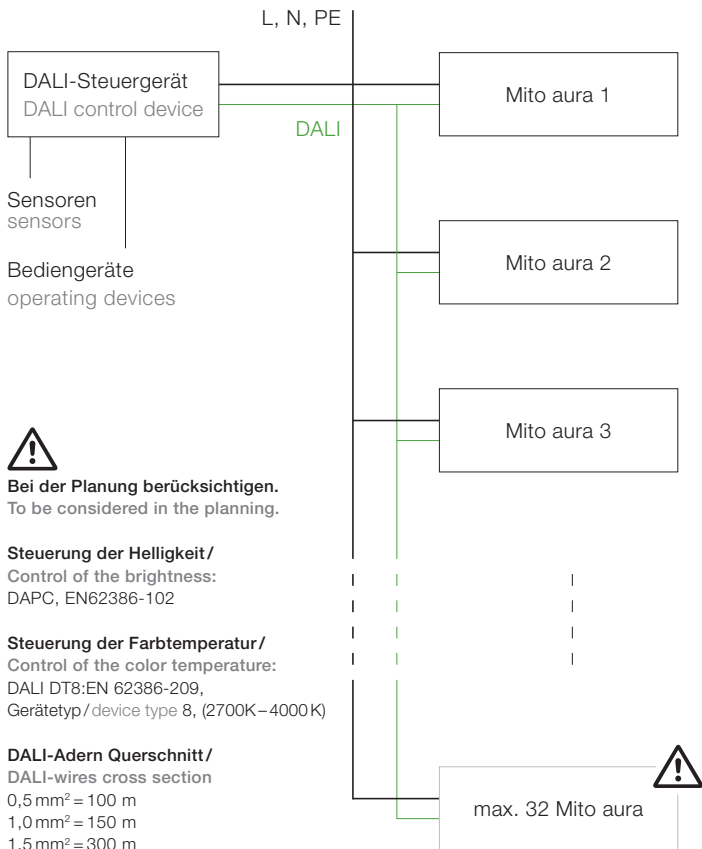



Montage

Mounting

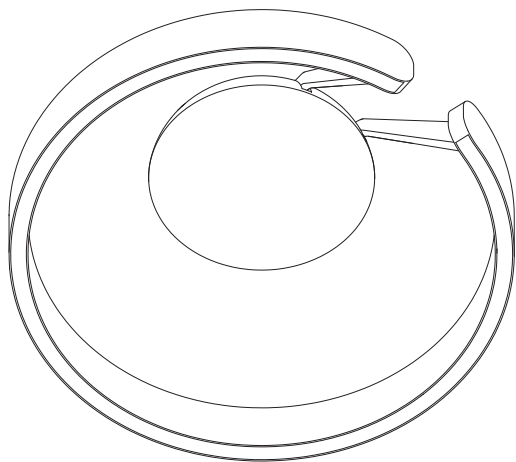

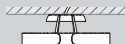

Deckenauslass / ceiling outlet  
230 V AC

Dübel / screw anchor

Mito aura

Schrauben / screws

Mito set box \*

Mito »air« box \*\*

Mito DALI box \*\*

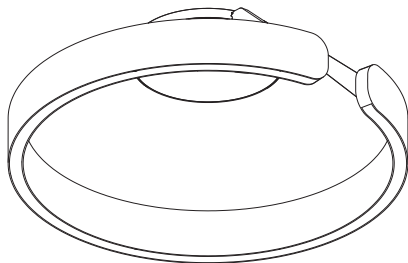
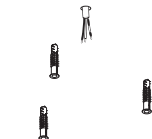

Torxschlüssel /  
Torx key



Inbusschlüssel /  
Allen key

Baldachin / canopy

\* standard \*\* optional

## Montage / Mounting

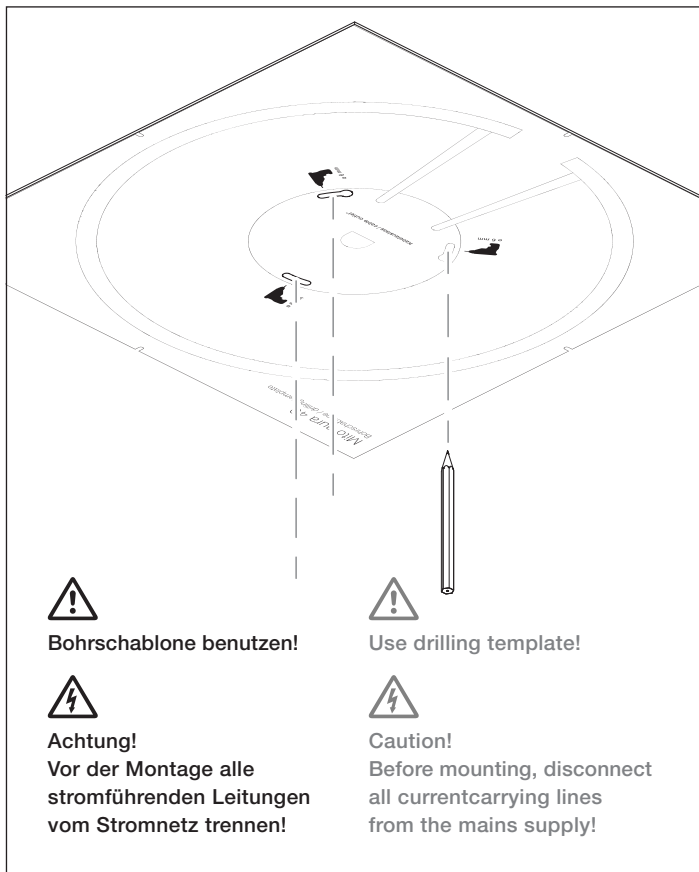

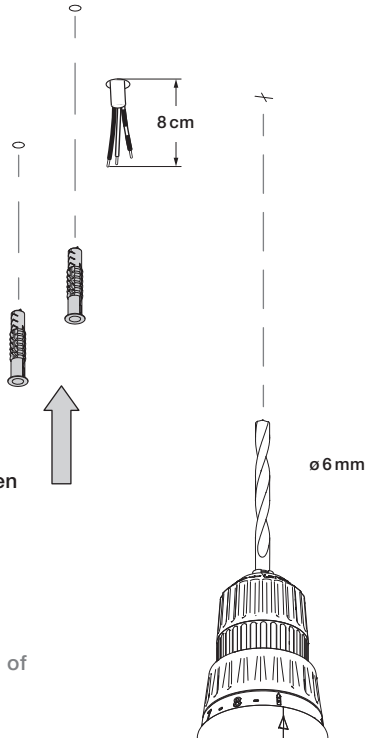

**Achtung!**  
Auf den Verlauf  
von Stromleitungen  
achten!



**Caution!**  
Check the routing of  
the power cables!

## Montage / Mounting

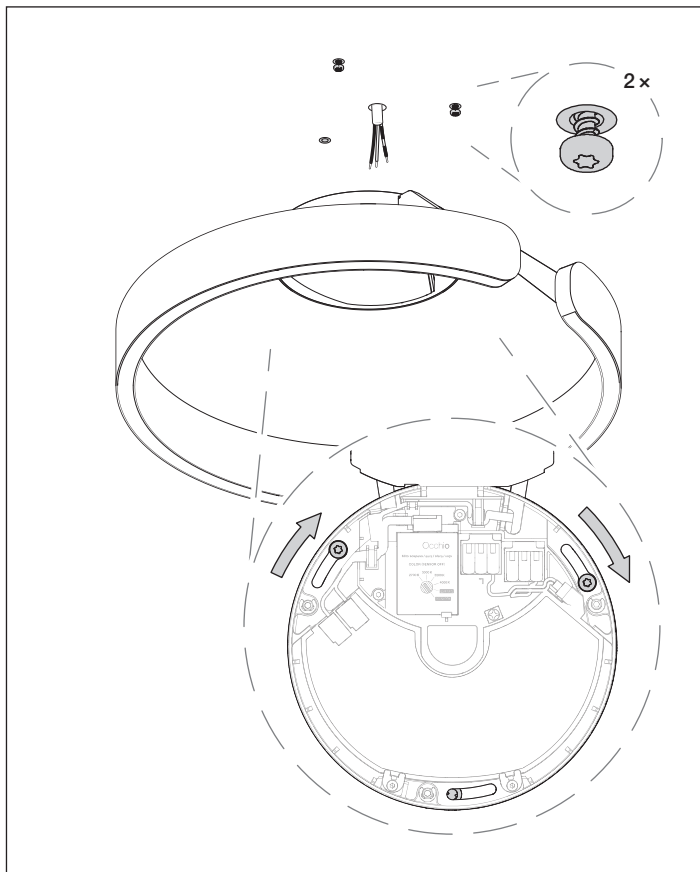



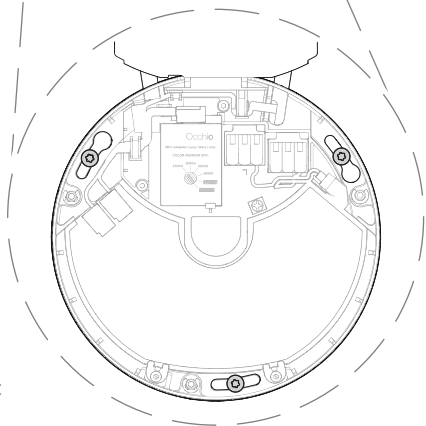
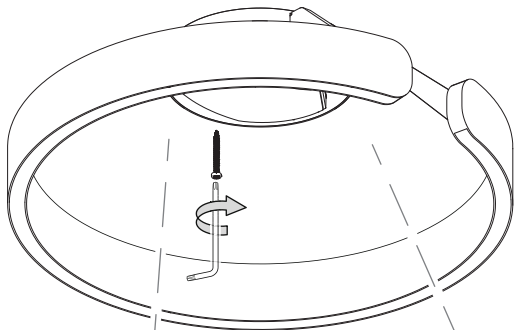
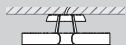

**Ausrichtung  
beachten und  
Schrauben  
fixieren.**

**Observe alignment  
and fix the screws.**

set box & air box



Erdungskabel  
eventuell kürzen.



If necessary shorten  
earth cable.

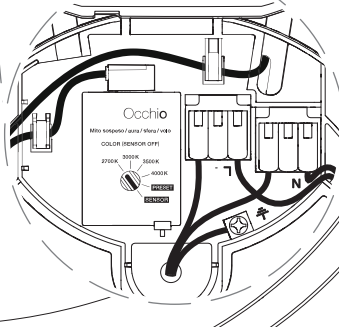

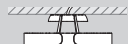

Durchverdrahtung (optional)  
mit set box & air box /  
through-wiring (optional)  
with set box & air box

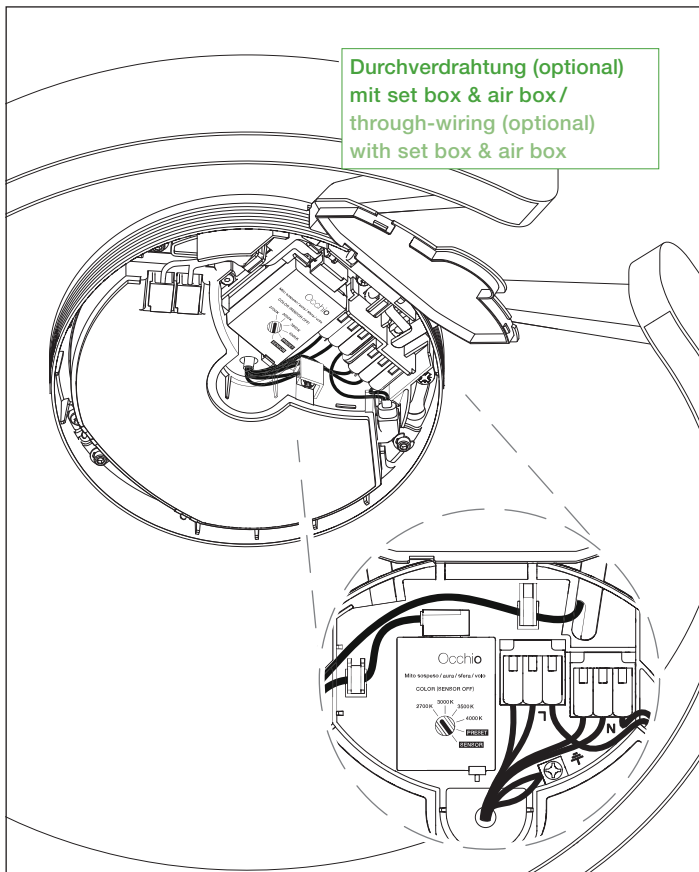

DALI box

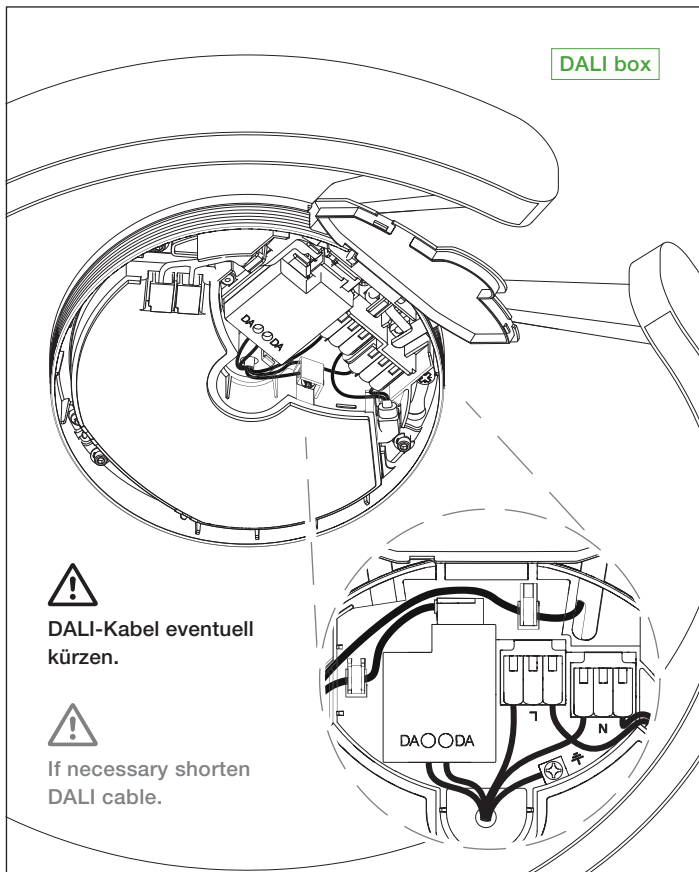

DALI-Kabel eventuell kürzen.



If necessary shorten DALI cable.

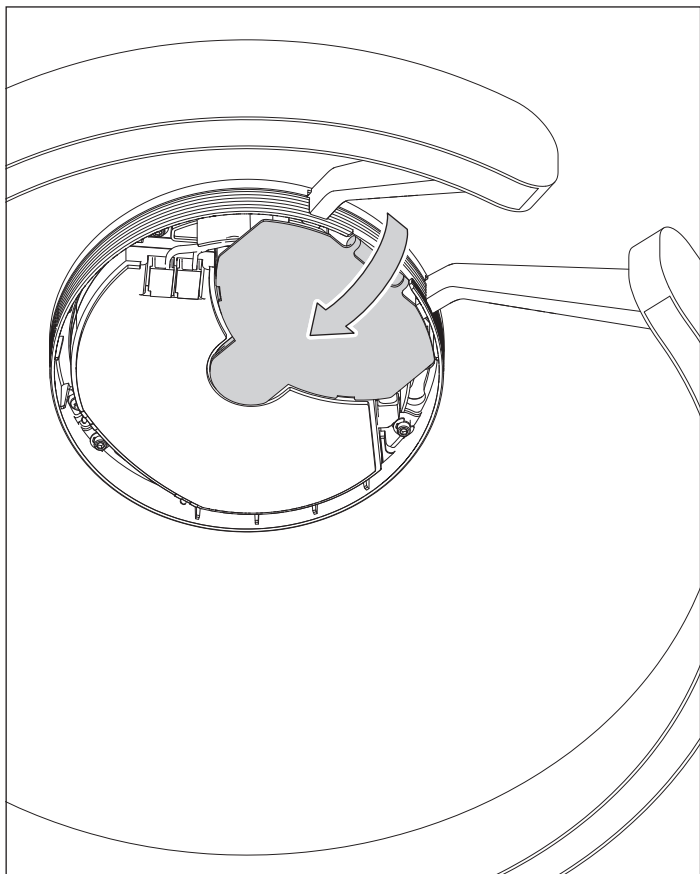
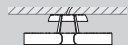

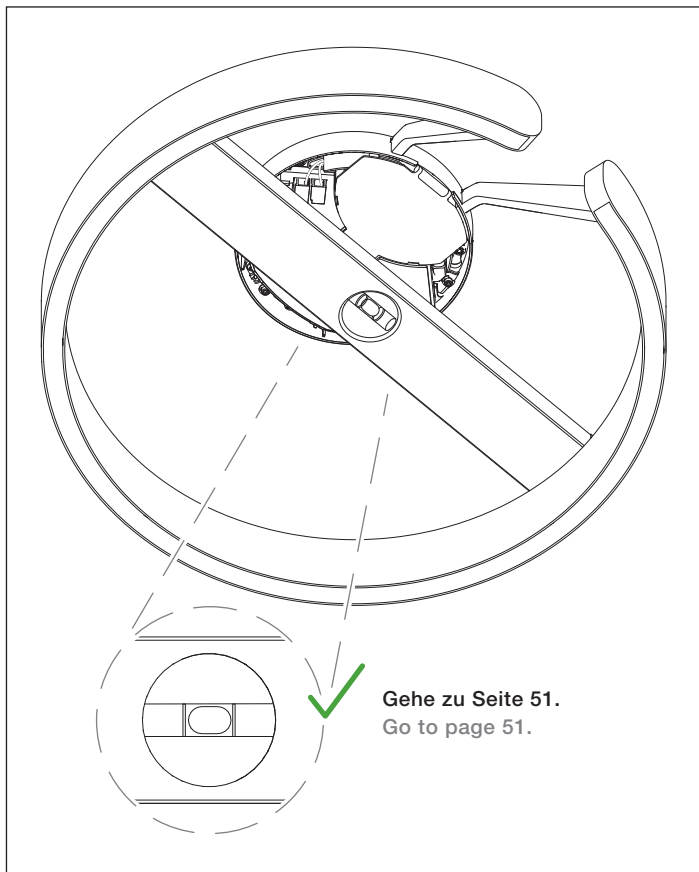

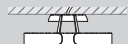

optional

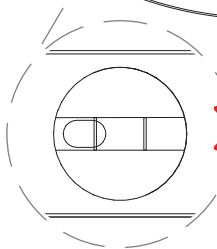
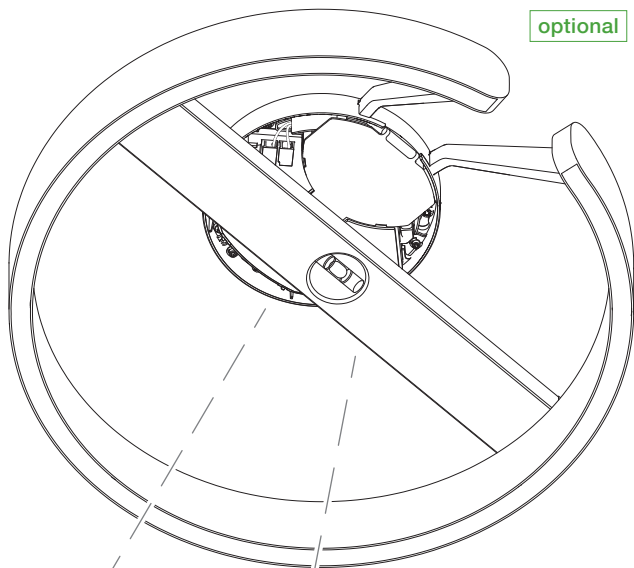

Gehe zu Seite 48.  
Go to page 48.

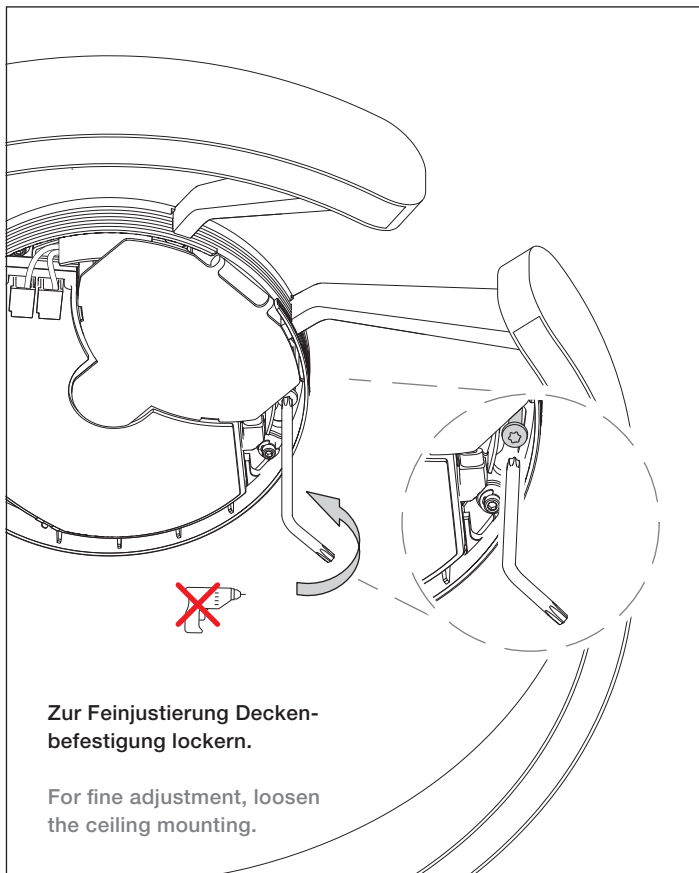



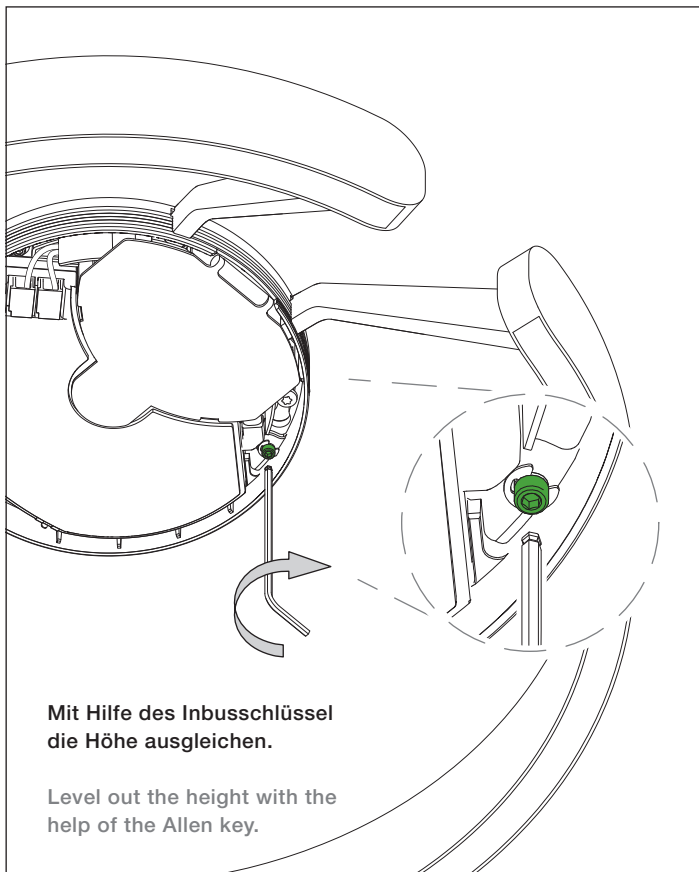
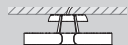

**Mit Hilfe des Inbusschlüssel  
die Höhe ausgleichen.**

**Level out the height with the  
help of the Allen key.**

## Montage / Mounting

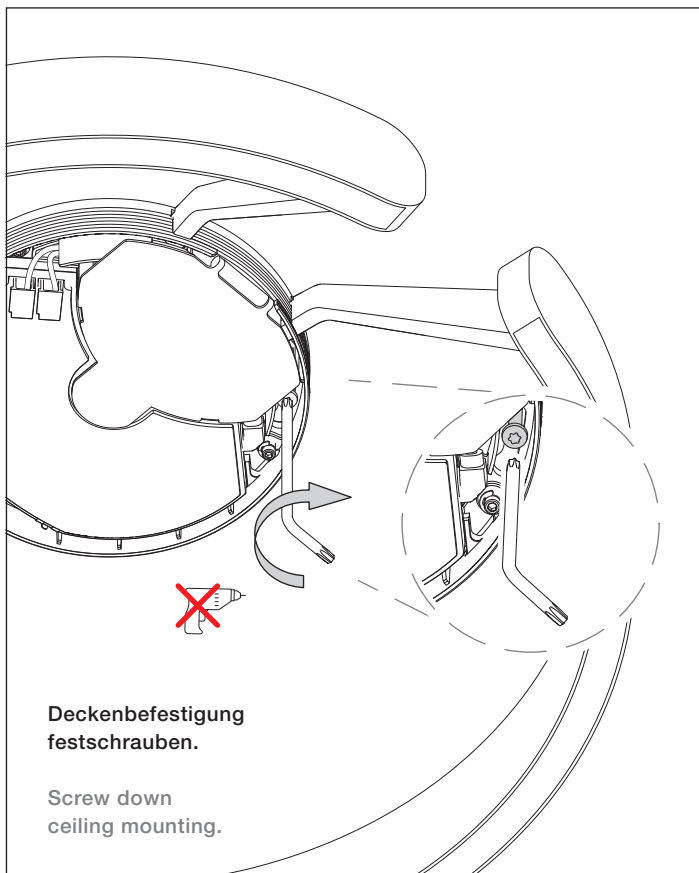

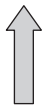
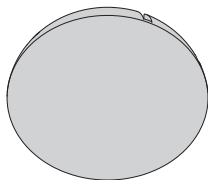
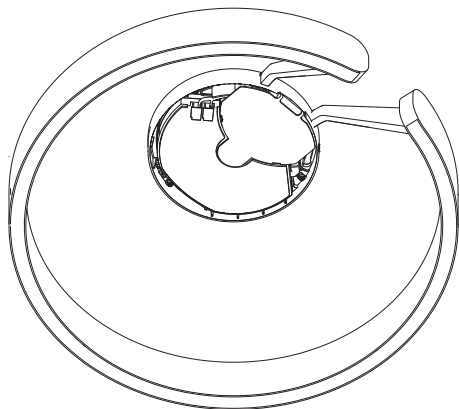
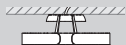

**Baldachin anbringen.**  
Attach canopy.

## Montage / Mounting

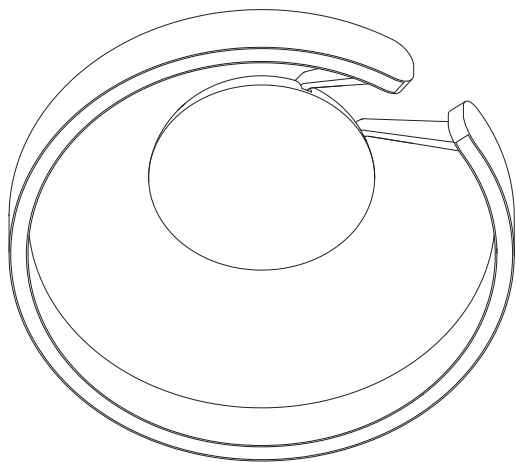

**Die Leuchte ist nun fertig  
montiert.**

**The luminaire is now  
completely assembled.**

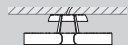



Steuerung mit  
der Occhio air  
App (optional)

Control using  
the Occhio air  
app (optional)

# Steuerung mit der Occhio air App (optional) Control using the Occhio air app (optional)

## Quick guide

Die Occhio air Produkte lassen sich mit der Occhio air App einrichten und steuern.

App installieren, App öffnen und angeschlossene Leuchten einrichten.

Occhio air products can be set up and controlled using the Occhio air app.

Install App, open App and set up connected luminaires.



## Occhio air tutorials

[www.occhio.com/air-tutorials](http://www.occhio.com/air-tutorials)

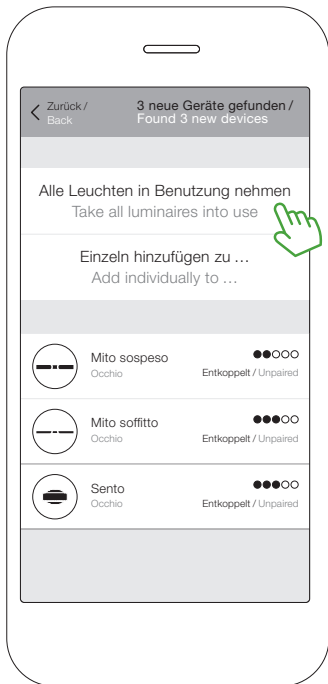

Ein Netzwerk (mein Netzwerk) wird autom. erstellt.

A network (my network) is autom. created.



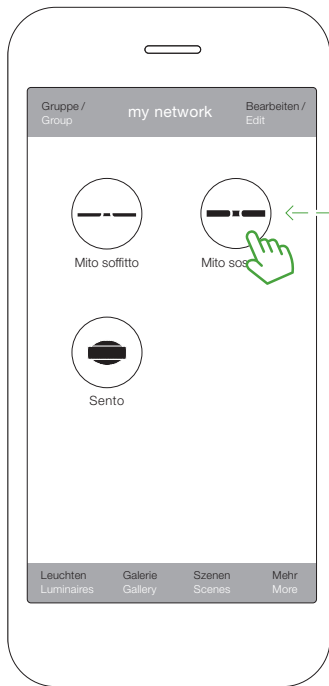

## Steuerungsgesten Control gestures

on / off  
on / off



antippen  
tap

dimmen  
dim



wischen  
swipe

up / down  
faden \*



wischen  
swipe

color tune \*\*  
magic move \*\*\*



halten  
hold



wischen  
swipe

Nur bei Leuchten mit beidseitigem Lichtaustritt \*,  
color tune \*\* oder magic move \*\*\*

Only for luminaires with double-sided light output \*,  
color tune \*\* or magic move \*\*\*

Und so werden die Leuchten gesteuert.  
And so the luminaires are controlled.

## Steuerung mit der Occhio air App (optional) Control using the Occhio air app (optional)

### Nutzung auf mehreren Geräten

### Use on several devices

Optional können Sie nun ihr  
erstelltes Netzwerk (mein  
Netzwerk) mit Anderen teilen.

Optionally, you can now share  
your created network (my  
network) with others.

1. Netzwerknamen  
vergeben

1. Assign name

### Occhio air tutorials

[www.occhio.com/air-tutorials](http://www.occhio.com/air-tutorials)

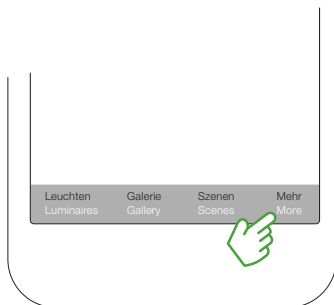

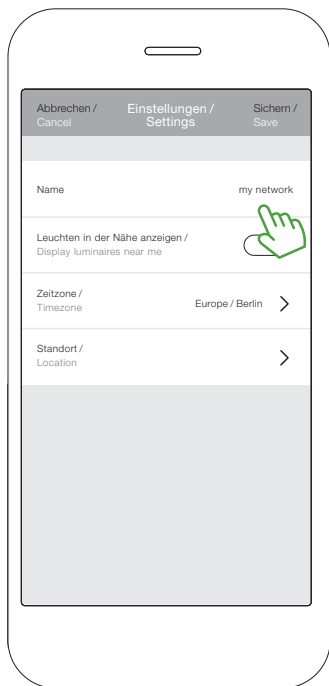

Netzwerkconfiguration → Netzwerkeinstellungen → Namen eingeben → Sichern  
Network setup → Network settings → enter name → save

# Steuerung mit der Occhio air App (optional) Control using the Occhio air app (optional)

## Netzwerk freigeben und schützen

Share and protect the  
network

## Occhio air tutorials

[www.occhio.com/air-tutorials](http://www.occhio.com/air-tutorials)

2. Netzwerk freigeben
2. Share network

Leuchten Luminaires	Galerie Gallery	Szenen Scenes	Mehr More
------------------------	--------------------	------------------	--------------



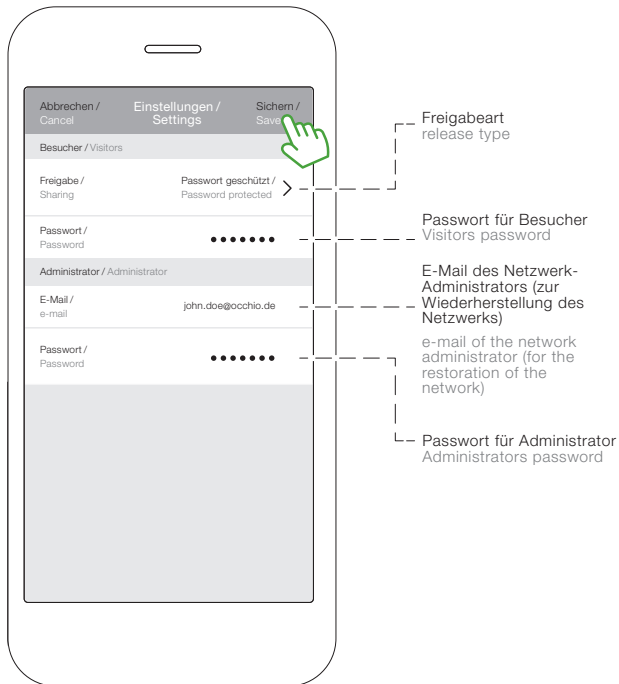

Netzwerkconfiguration → Freigabeoptionen →  
 Passwort geschützt → Sichern  
 Network setup → Sharing settings →  
 Password protected → save



Steuerung mit  
dem Occhio air  
controller  
(optional)

Control using  
the Occhio air  
controller  
(optional)

# Steuerung via Occhio air controller (optional)

## Control via Occhio air controller (optional)

### Occhio air controller

Intuitiv bedienbare Fernbedienung mit vier programmierbaren Tasten (Einrichtung via Occhio air App). Unabhängig von der App können einzelne Leuchten, Gruppen und Szenen gesteuert werden. Optional mit Wandhalterung erhältlich.

Maximaler Bedienkomfort und umfassende Steuerung via Bluetooth 4.0 (Bluetooth Low Energy). Schalten, dimmen, faden, color tune, elektrische Höhenverstellung von einzelnen Leuchten, Gruppen und Szenen.

### Occhio air controller

Intuitive remote control with four programmable buttons (setup via Occhio air app). Individual luminaires, groups and scenes can be controlled regardless of the app. Available with optional wall mount.

Maximum ease of use and total control via Bluetooth 4.0 (Bluetooth low energy). Switching, dimming, fading, color tune, electric height adjustment of individual luminaires, groups and scenes.



Zum Einrichten des Occhio air controllers wird die Occhio air App benötigt. Eine Video-Kurzanleitung kann unter: [www.occhio.com/air-tutorials](http://www.occhio.com/air-tutorials) aufgerufen werden.

To set up the Occhio air controller, the Occhio air app is required. A video quick start guide can be called up at [www.occhio.com/air-tutorials](http://www.occhio.com/air-tutorials).



## schalten/switch

⏏ - ⏏⏏⏏ schalten einzelner Leuchten, Gruppen oder Szenen

⏏ - ⏏⏏⏏ switch individual luminaires, groups or scenes

## fading\*

⤴ ⤵ fading einzelner Leuchten, Gruppen oder Szenen (up/down Lichtverhältnis einstellen)

⤴ ⤵ fading of individual luminaires, groups or scenes (set up/down light ratio)

## dimmen/dim

⊕ ⊖ dimmen einzelner Leuchten, Gruppen oder Szenen

⊕ ⊖ dim individual luminaires, groups or scenes

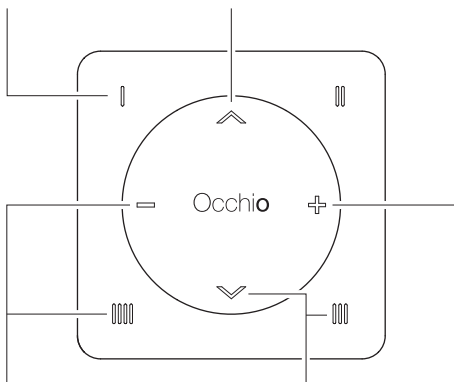

## color tune\*\*

⏏ - ⏏⏏⏏ und ⊕ ⊖ Farbtemperatur einzelner Leuchten, Gruppen oder Szenen einstellen

⏏ - ⏏⏏⏏ and ⊕ ⊖ adjust color temperature of individual luminaires, groups or scenes

## magic move\*\*\*

⏏ - ⏏⏏⏏ und ⤴ ⤵ elektrische Höhenverstellung einzelner Leuchten, Gruppen oder Szenen

⏏ - ⏏⏏⏏ and ⤴ ⤵ electronic height adjustment of individual luminaires, groups or scenes



Anhang

Appendix

## Pflegehinweise

### Care instructions

Leuchte nur in abgekühltem Zustand reinigen! Zur Reinigung der Leuchte ein trockenes Mikrofasertuch verwenden. Detaillierte Pflegehinweise sind unter [www.occhio.com/de/company/faq](http://www.occhio.com/de/company/faq) zu finden.

Always allow the luminaire to cool down before cleaning! To clean the luminaire, use a dry microfibre cloth. Detailed care instructions are available at [www.occhio.com/en/company/faq](http://www.occhio.com/en/company/faq).

## Info & Kontakt

### Information & contact





Weitere Fragen beantwortet gerne  
Ihr Occhio Fachhändler

Your Occhio specialist retailer will  
gladly answer any other questions

**[www.occhio.com](http://www.occhio.com)**  
**[info@occhio.com](mailto:info@occhio.com)**

# Technische Daten

## Technische Daten Leuchte

Artikelbezeichnung	Mito aura 40, Mito aura 60
Abmessungen	Mito aura 40: head ø 400 mm, H 52 mm, Leuchte ø 400 mm, H 135 mm, Baldachin ø 179 mm, H 30 mm Mito aura 60: head ø 600 mm, H 52 mm, Leuchte ø 600 mm, H 135 mm, Baldachin ø 179 mm, H 30 mm
Schutzklasse	2
Anschluss	230 V AC
Dimmung	via »touchless control«, Occhio air, DALI oder via Phasenabschnittdimmer (Liste kompatibler Dimmer: <a href="http://www.occhio.com/dim">www.occhio.com/dim</a> , Phasenabschnittdimmer nicht kombinierbar mit »touchless control«, Occhio air oder DALI)
Material	Aluminium, Stahl, lackiert, PVD-beschichtet, Kunststoff, optisches Silikon, Fiberglas
LED-Leistung	Mito aura 40: 40 W Mito aura 60: 60 W
Zulässige Betriebsbedingung	max. 30°C nur im Innenbereich betreiben
Prüfzeichen	<b>IP 20</b> <b>CE</b>    



### Technische Daten Leuchtmittel





Leuchtmittel	Occhio »color tune« LED
Ausführung	LED-board
Lebensdauer	> 50.000 Std.

### Entsorgung

Bei örtlicher Entsorgungsstelle entsorgen. Mito aura ist recyclebar;  
RoHS-konform. **Nicht in den Hausmüll geben!**

# Technical data

## Technical data luminaire

Product designation	Mito aura 40, Mito aura 60
Dimensions	Mito aura 40: head ø 400 mm, H 52 mm, luminaire ø 400 mm, H 135 mm, canopy ø 179 mm, H 30 mm Mito aura 60: head ø 600 mm, H 52 mm, luminaire ø 600 mm, H 135 mm, canopy ø 179 mm, H 30 mm
Safety class	2
Connection	230 V AC
Dimming	via »touchless control«, Occhio air, DALI or via trailing-edge phase-cut dimmer (for a list of compatible dimmers, see <a href="http://www.occhio.com/dim_en">www.occhio.com/dim_en</a> , trailing-edge phase-cut dimmer can not be combined with »touchless control«, Occhio air or DALI)
Material	aluminium, painted, PVD-coated steel, plastic, optical silicone, fibreglass
LED power	Mito aura 40: 40 W Mito aura 60: 60 W
Permitted operating conditions	max. 30°C for indoor use only
Test symbols	IP 20 CE    



### Technical data light source

---

Light source	Occhio »color tune« LED
Version	LED-board
Lifetime	> 50.000 h

---

### Disposal

---

Dispose of at a local disposal site. Mito aura is recyclable and RoHS compliant. **Do not dispose of with the household waste!**

---

# Occhio

[www.occhio.com](http://www.occhio.com)



010405944551196710