

# Artemide®

## STELLAR NEBULA TABLE

design  
BIG

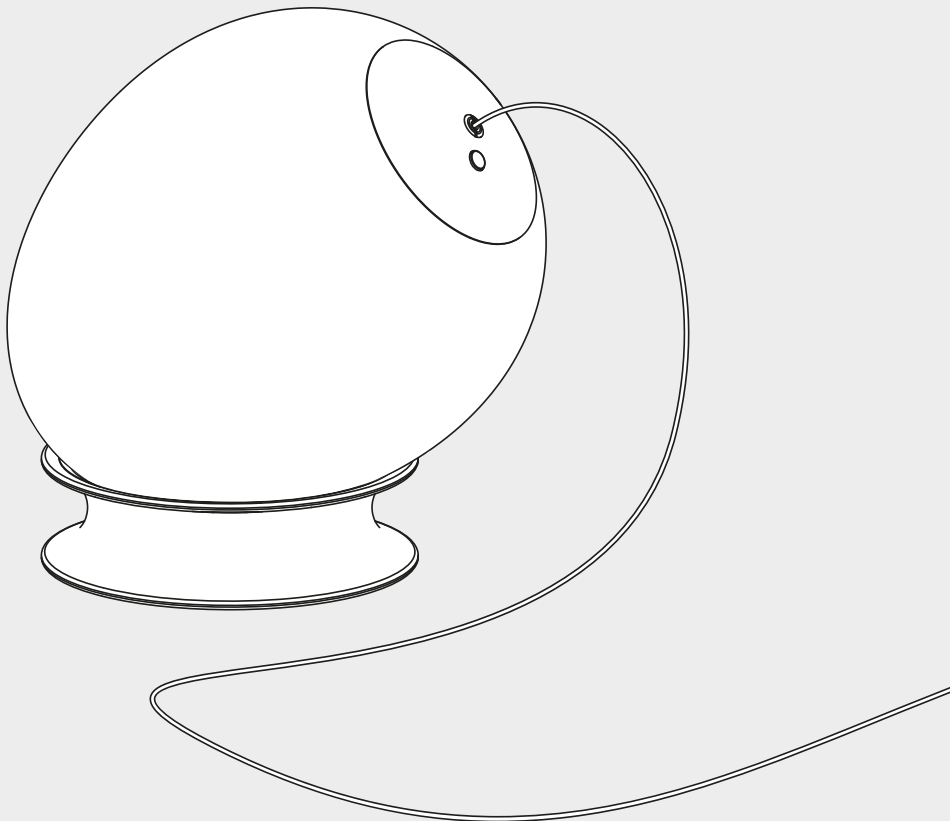



i

FOR USA/  
CANADA ONLY

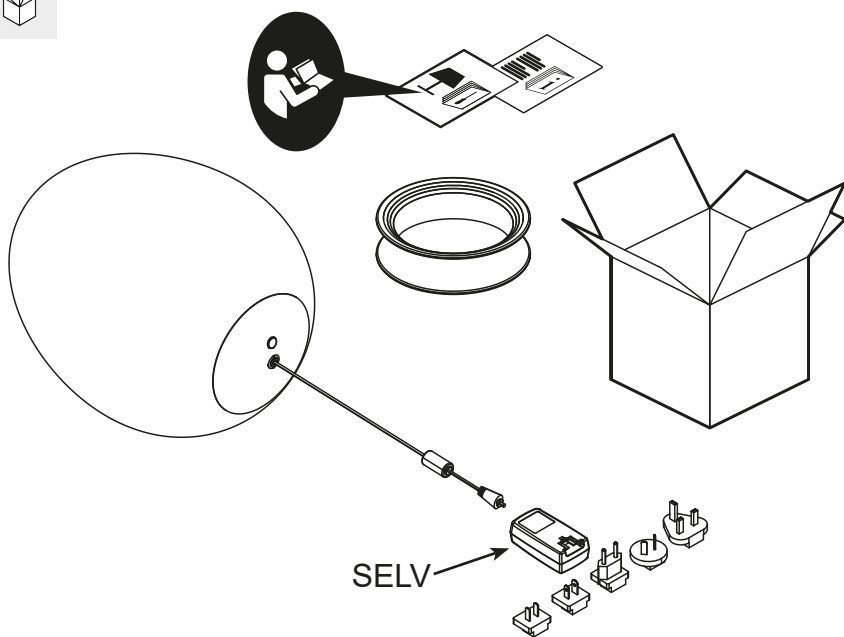
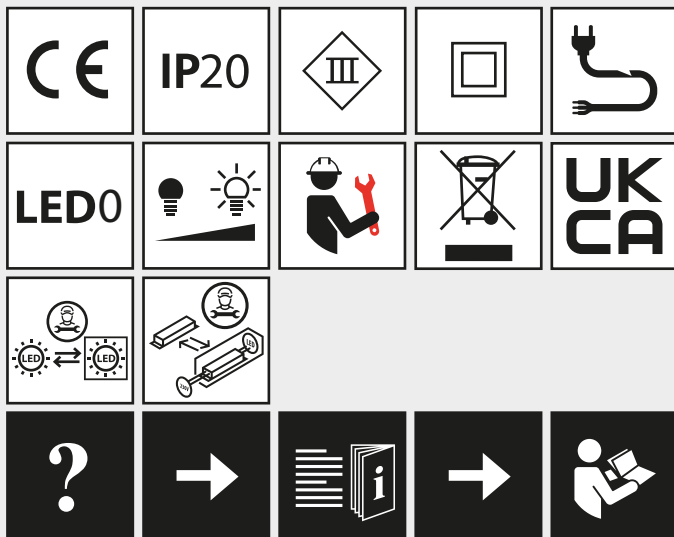

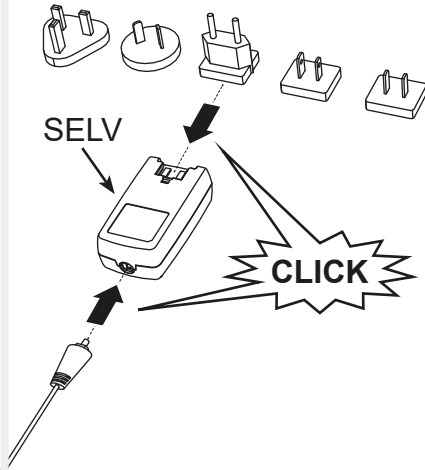
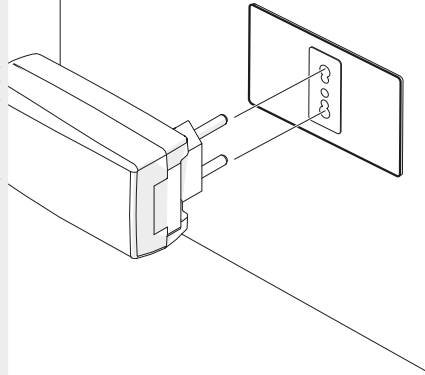
**1****2**

**FOR USA/  
CANADA ONLY**

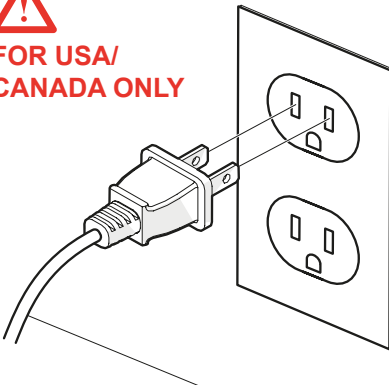

#### IMPORTANT SAFETY INSTRUCTIONS

This portable lamp has a polarized plug (one blade is wider than the other one).

As a safety feature, this plug will fit in a polarized outlet only one way. If the plug does not fit fully in the outlet, reverse the plug. If it still does not fit, contact a qualified electrician. Never use with an extension cord unless plug can be fully inserted. Do not attempt to defeat this safety feature.

#### INSTRUCTIONS IMPORTANTES DE SECURITE

Cette lampe portable a une fiche polarisée (une lame est plus grande que l'autre). Comme caractéristique pour réduire les risques de choc électrique, cette fiche n'engage qu'une prise polarisante. Si la fiche n'engage pas complètement la prise, il faut la renverser; si elle ne s'engage toujours pas, mettez vous en rapport avec un électricien qualifié. Ne jamais utiliser avec un prolongateur si la fiche ne pénètre pas complètement. Ne pas changer la fiche.

3

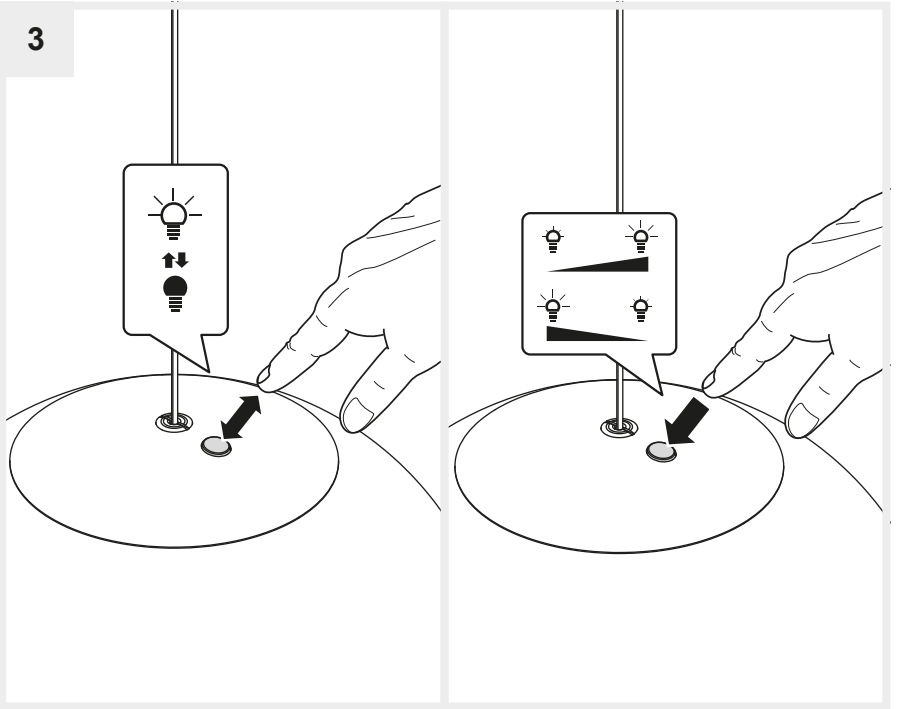

4

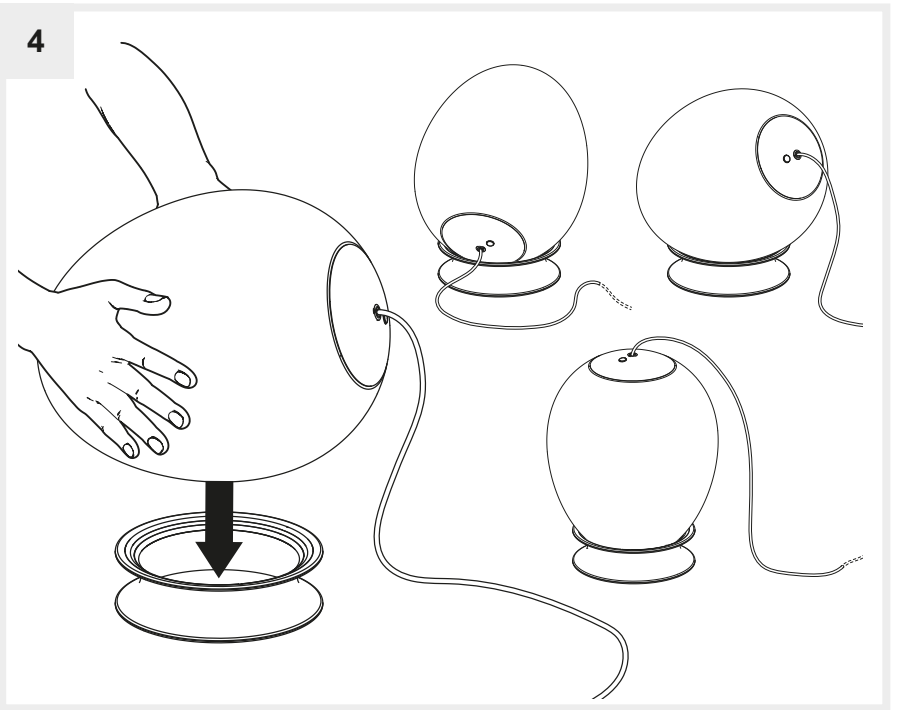

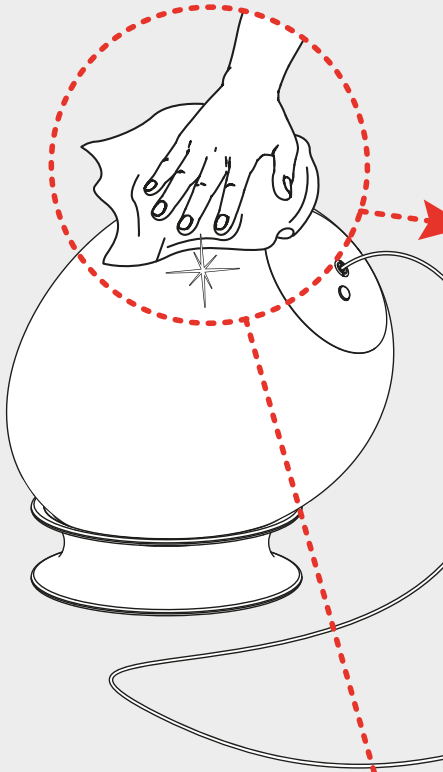

**UTILIZZARE SOLO PANNI IN MICROFIBRA ANTI-GRAFFIO**

**USE ONLY ANTI-SCRATCH MICROFIBRE CLOTH**

**UTILISER UNIQUEMENT DES CHIFFONS EN MICROFIBRE  
RÉSISTANTS AUX RAYURES**

**UTILICE ÚNICAMENTE PAÑOS DE MICROFIBRA  
RESISTENTES A LOS ARAÑAZOS**

**NUR KRATZFESTE MIKROFASERTÜCHER VERWENDEN**

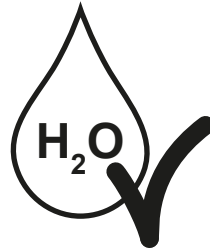

**UTILIZZARE SOLO PANNI IN  
MICROFIBRA ANTI-GRAFFIO**

**USE ONLY ANTI-SCRATCH  
MICROFIBRE CLOTH**

**UTILISER UNIQUEMENT DES  
CHIFFONS EN MICROFIBRE  
RÉSISTANTS AUX RAYURES**

**UTILICE ÚNICAMENTE PAÑOS  
DE MICROFIBRA RESISTENTES  
A LOS ARAÑAZOS**

**NUR KRATZFESTE  
MIKROFASERTÜCHER  
VERWENDEN**

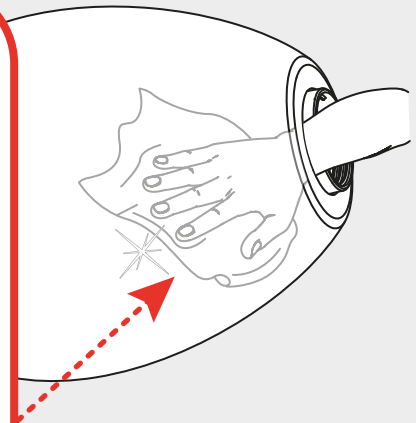

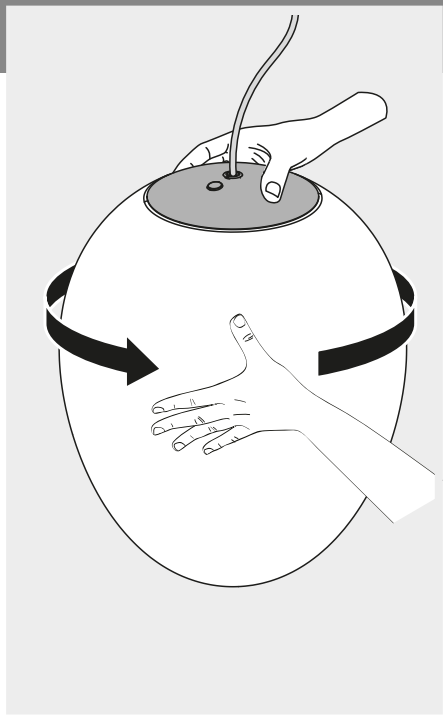
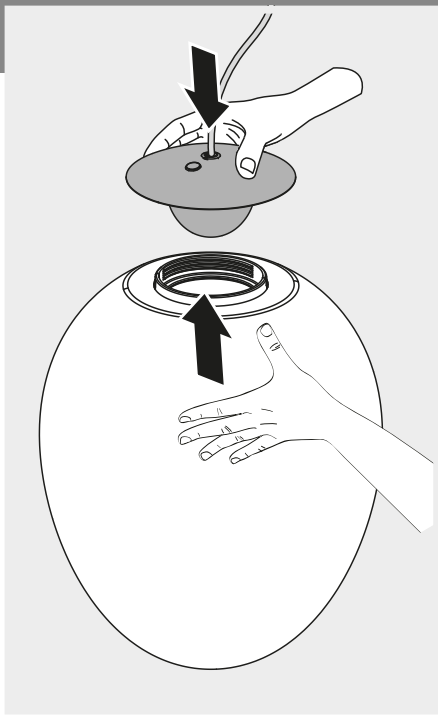

# Artemide®



## **Artemide**

via Bergamo, 18  
20006 Pregnana M.se (MI)  
ITALIA

tel. +39 02 935 181  
fax +39 02 935 90 254  
fax +39 02 935 90 496

[www.artemide.com](http://www.artemide.com)

VAT IT00846890150

## **Artemide Inc.**

250 Karin Lane  
Hicksville, NY 11801

tel. 631 694 9292  
Toll Free 1-877-Art-9111  
Fax 631 694 9275

[www.artemide.net](http://www.artemide.net)

## **Artemide Ltée/Ltd.**

11105 rue Renaude Lapointe  
Montréal, Québec H1J 2T4

Tel. 514 323 6537  
Toll Free 888 777 2783  
Fax 514 323 8864

[www.artemide.net](http://www.artemide.net)

cod. Y513001712A