

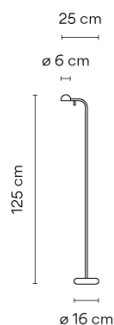



1660

Design von Ichiro Iwasaki

Stehleuchte. Design von Ichiro Iwasaki. Diese Leselampe verfügt über einen Diffusor mit verstellbarem Leuchtenkopf. Erhältlich in matter Lackierung in den Farben weiß, schwarz, creme und grün.

Modellblatt



Farbe	 62 Grün NCS S 3010-G20Y
	 23 Warm White test ral
	 04 Schwarz NCS 9000N

LED-Temperaturfarbe 2700 K

Dimmen On/Off

Installationstyp Mit Stecker

Materialien Kopf: Alu
Basis: Zinc Alloy
Diffuser: PC- Polycarbonat
Stangen: Edelstahl

Lichtquelle 1 x LED 4,48W 350mA



LED CRI>90 452.95 lm 100.66
2700 K

Driver Constant Current 350 100~240
V V 50~60 Hz HZ

Bemerkungen Schalter am Kabel



Bi-volt 50-60Hz

Anwendung Steh- und Tischlampen

Verpackung 1 Kartons
0.33 m x 0.265 m x 1.496 m
Bruttogewicht 7.45
Nettogewicht 3.8
Vol. 0.1308

Lichteffect**Lesen**

Intensive, blendfreie Arbeitsbeleuchtung

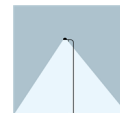
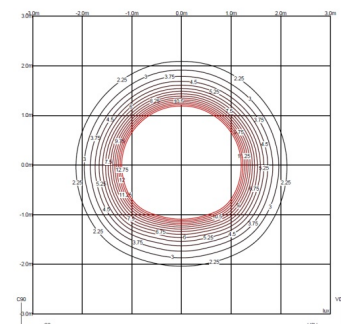
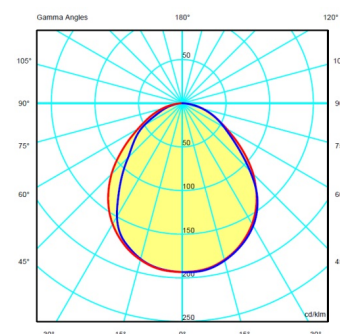
**Photometrische Daten**

Effizienz 31.88 lm/W
Koordinatensystem CG
Gesamtfluss 192.18 lm
Höchster Wert 80.54 cd

Alle unsere Produkte haben eine fünfjährige Garantie. Lesen Sie unsere rechtlichen Bedingungen unter www.vibia.com/warranty

Vibia Lighting, S.L.U.

Office / Oficina
Progrés 4-6. 08850 Gavà. Barcelona, Spain.

International T +34 934 796 971
Spain / Portugal T +34 934 796 970

customer.service@vibia.com
vibia.com