

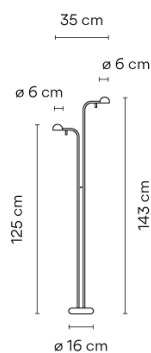



1670

Design By Ichiro Iwasaki

Floor lamp. Design by Ichiro Iwasaki. This reading lamp is characterized by having two diffusers with adjustable heads. Available in white, black, cream and green matt finishes.

Model Sheet



Finish	 23 Warm White test ral
	 62 Green NCS S 3010-G20Y
	 04 Black NCS 9000N

LED temperature color 2700 K

Dimming On/Off

Installation type Plug-in

Materials Head: Aluminium
Base: Zinc Alloy
Diffuser: PC- Polycarbonate
Rods: Steel

Light source 2 x LED 4,48W 350mA



LED CRI>90 905.9 lm 100.66
2700 K

Driver Constant Current 350 100~240
V V 50-60 Hz HZ

Remarks Switch on the cable



Bi-volt 50-60Hz

Application Floor and Table Lamps

Packaging 1 Box
0.33 m x 0.265 m x 1.496 m
Gross weight 8,45
Net weight 4,8
Vol. 0.1308

Lighting effect

Reading

High intensity, glare-free task lighting



Photometric Data

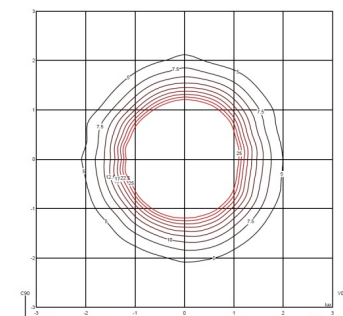
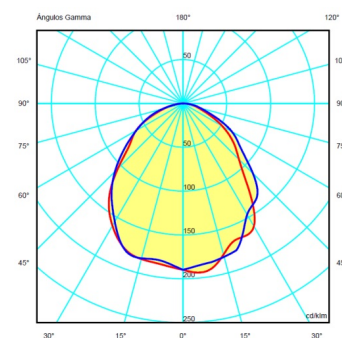

Efficiency 31.71 lm/W
Coordinate System CG
Total Flux 382.34 lm
Maximum Value 161.13 cd

Other Applications

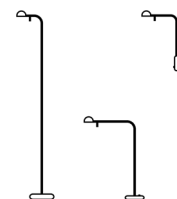

All of our products come with a five-year warranty. Check our legal terms at www.vibia.com/warranty

Vibia Lighting, S.L.U.

Office / Oficina
Progrés 4-6. 08850 Gavà. Barcelona, Spain.

International T +34 934 796 971
Spain / Portugal T +34 934 796 970

customer.service@vibia.com
vibia.com