

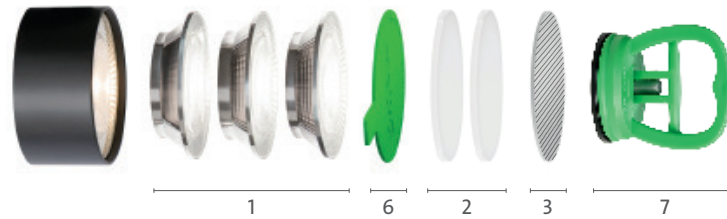

■ wi4-optisches Zubehör und Werkzeuge *wi4-optical accessories and tools*

STRAHLERKOPFZUBEHÖR SPOTLIGHT ACCESSORIES

TECHNISCHE DATEN TECHNICAL DATA		CE
1 Linsenoptik <i>lens optic</i>	spot 12° <i>wi4-li-12°</i> medium 24° <i>wi4-li-24°</i> flood 38° <i>wi4-li-38°</i>	
2 LSD Aufweitungsversatz Abstrahlwinkel vergrößern <i>LSD light shaping diffusor</i> <i>increase beam angles</i>	30° <i>wi4-vl-30°</i> 60° <i>wi4-vl-60°</i>	
3 SKL Skulpturenlinse (spot 12°) elliptische Lichtverteilung <i>SKL sculpture lens (spot 12°)</i> <i>elliptic light distribution</i>	14° x 52° <i>wi4-vl-sk</i>	
6 Silikonpad <i>silicone pad</i>	<i>wi4-sp</i>	
7 Saugheber <i>vacuum cup</i>	<i>sh1</i>	



WICHTIG IMPORTANT

Zubehör und Werkzeuge sind erhältlich bei mawa. Werkzeuge sollten entsprechend der Montageanleitung gewählt werden!

Accessories and tools are available from mawa. Tools have to be chosen according to mounting manual!

! WICHTIG: Pro Linseneinheit ist jeweils nur ein Zubehörteil kombinierbar.

IMPORTANT: *Only one accessory per lens unit can be combined.*

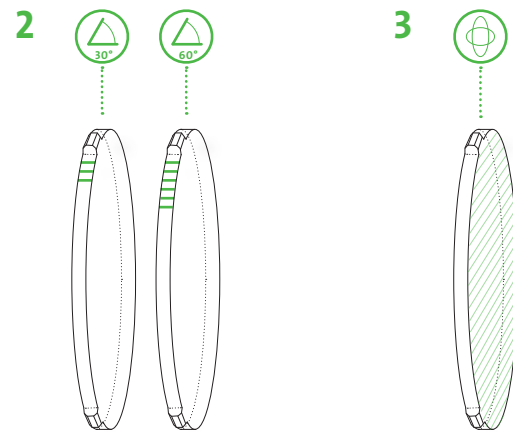
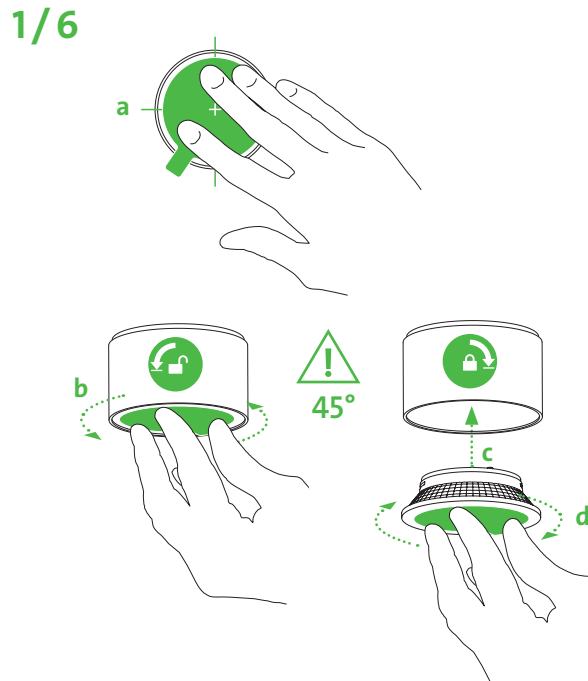

Linse	LSD 30°	LSD 60°
12° spot	32°	61°
24° medium	38°	64°
38° flood	48°	71°

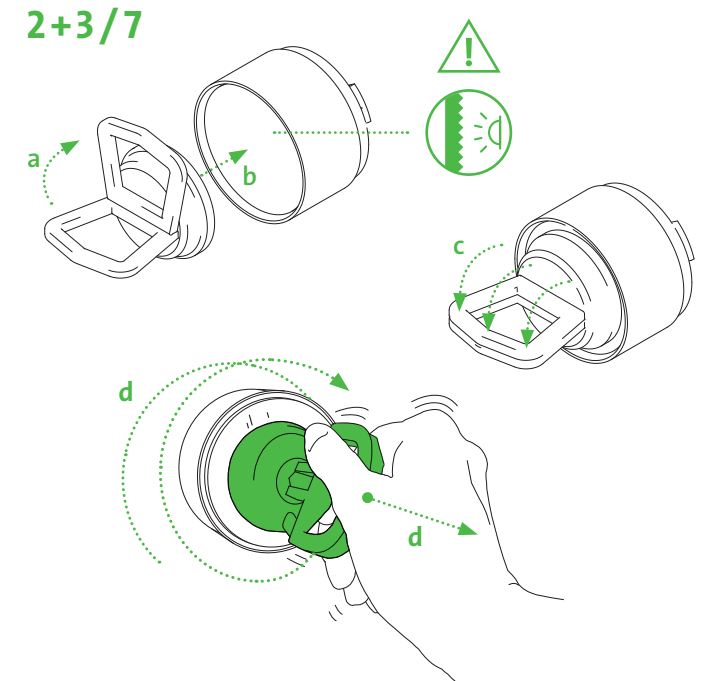



■ wi4 - shutter und wabenraster *wi4 - shutters and honeycomb*

STRAHLERKOPFZUBEHÖR SPOTLIGHT ACCESSORIES

TECHNISCHE DATEN TECHNICAL DATA

- 4 Wabenraster, schwarz wi4-wa-s
honeycomb, black
 (für seitliche Entblendung)
(cleaner more balanced spread of light)
- 5 Shutter (schwarz/weiß)
shutters (black/white)
 - 19 mm symmetrisch *symmetrical*
wi4-sh-s-9005/-9016
 - 38 mm symmetrisch *symmetrical*
wi4-sh-m-9005/-9016
 - 19 – 76 mm asymmetrisch *asymmetrical*
wi4-sh-las-9005/-9016
- 8 Handschuhe *cotton gloves*

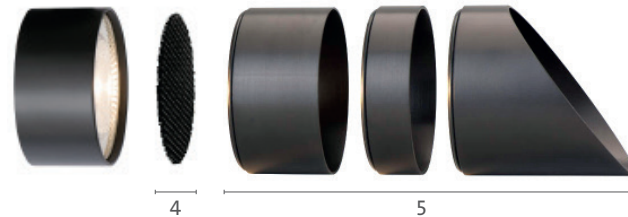

WICHTIG *IMPORTANT*

Zubehör und Werkzeuge sind erhältlich bei mawa. Werkzeuge sollten entsprechend der Montageanleitung gewählt werden!

Accessories and tools are available from mawa. Tools have to be chosen according to mounting manual!

- ! **WICHTIG:** Pro Linseneinheit ist jeweils nur ein Zubehörteil kombinierbar.

IMPORTANT: Only one accessory per lens unit can be combined.

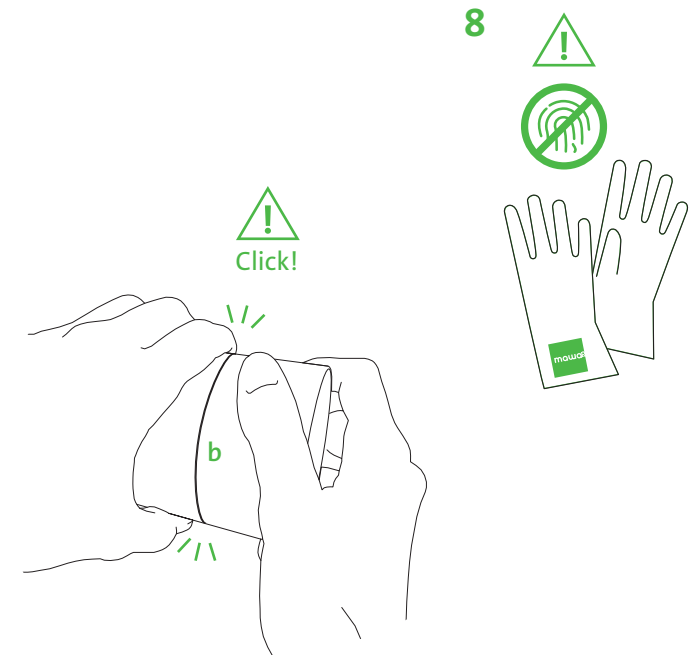
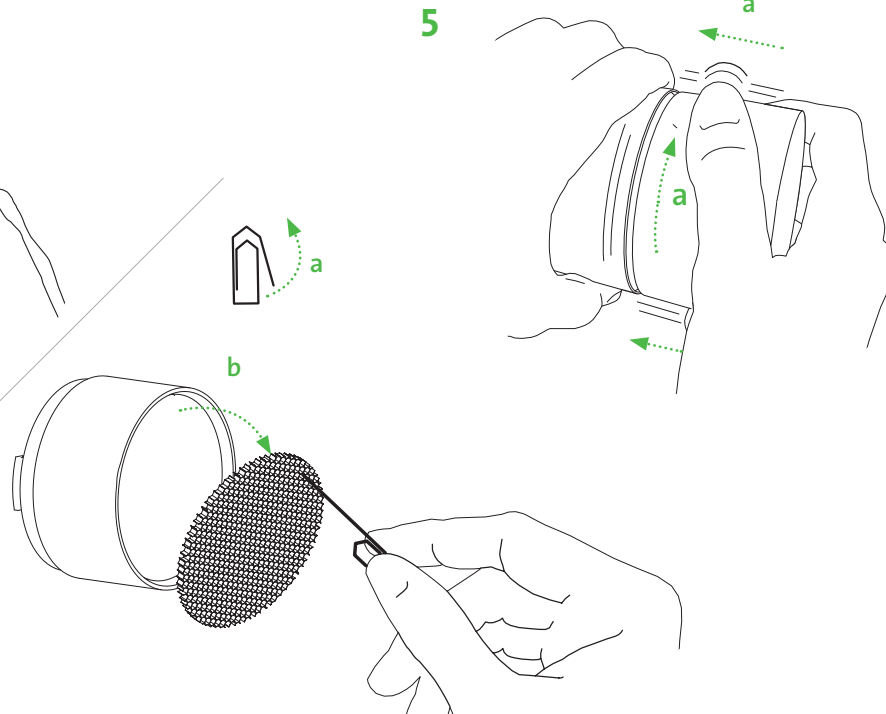
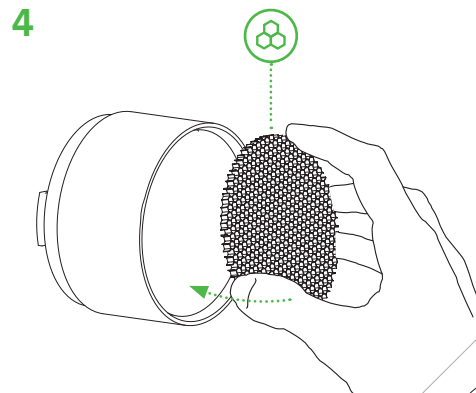



■ wi4-optisches Zubehör und Werkzeuge *wi4-optical accessories and tools*

STRAHLERKOPFZUBEHÖR SPOTLIGHT ACCESSORIES

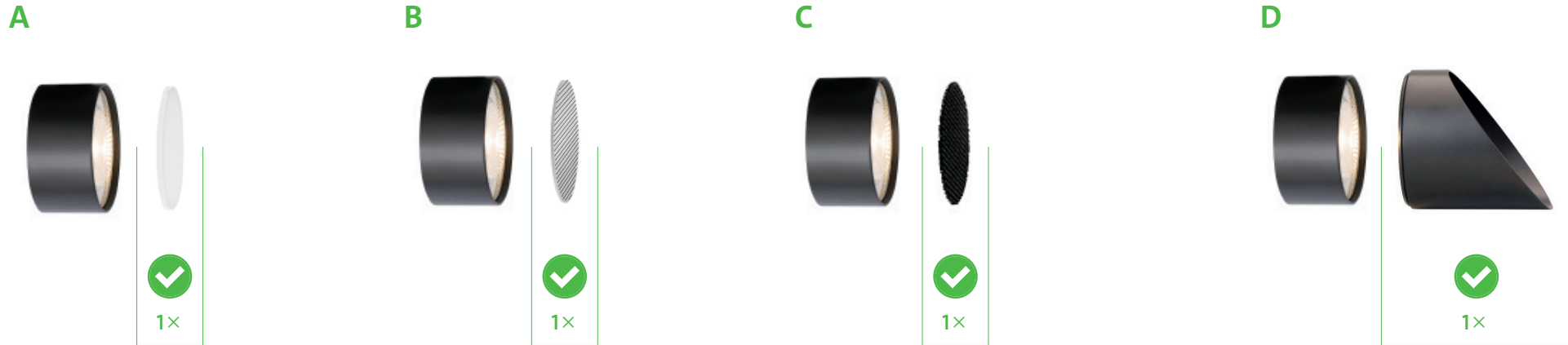

Wichtig: Bitte maximal 1 Zubehörteil pro Linseneinheit platzieren!
Important: Please combine max. 1 accessory per lens unit!

