

Occhio

Sito lato VOLT

Montageanleitung
Mounting instructions

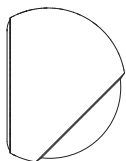

Inhalt / Contents

Sicherheitshinweise	04	Safety precautions	05
Produktbeschreibung	06	Product description	07
Montage		Mounting	
Sito lato VOLT	09	Sito lato VOLT	09
Anhang	29	Appendix	29
Pflegehinweise	30	Care instructions	30
Info & Kontakt	31	Information & contact	31
Technische Daten	32	Technical data	33

Sicherheitshinweise

Lesen Sie die Montage-/Gebrauchsanweisung sorgfältig durch, bevor Sie die Leuchte installieren. Beachten Sie die Sicherheitshinweise in dieser Anleitung genau und bewahren Sie die Anleitung auf.



Dieses Zeichen macht Sie auf eine gefährliche Situation aufmerksam, die eine schwere Verletzung oder den Tod nach sich ziehen kann, wenn sie nicht beachtet wird. Es macht Sie zudem auf mögliche Sachschäden und andere wichtige Informationen in Verbindung mit diesem Produkt aufmerksam.



Die Montage von Elektrokomponenten darf nur von qualifiziertem Fachpersonal durchgeführt werden. Reparaturarbeiten dürfen nur von autorisiertem Fachpersonal oder dem Hersteller durchgeführt werden. Vor allen Arbeiten an der Leuchte (Installation, Reinigung etc.) diese unbedingt vom Stromnetz trennen.



Dieses Zeichen macht Sie auf Situationen aufmerksam, bei denen Sie direkt in das Licht der LED blicken könnten. Dies kann zu Nachbildern und bei längerer Dauer zu Schädigungen der Augen führen.



Sicherheitsabstand zu brennbaren Objekten einhalten: 20 cm!



Dieses Zeichen macht Sie auf heiße Oberflächen aufmerksam, deren Berührung Verbrennungen zur Folge haben können.

Achtung: Die Oberfläche der Leuchte kann nach längerer Betriebsdauer heiß sein! Vor allen Arbeiten an der Leuchte (Montage usw.), Leuchte immer ausschalten und mindestens 30 Minuten abkühlen lassen. Nur zur Installation außerhalb des Handbereichs vorgesehen.

Safety precautions

Read through the mounting/ use instructions carefully before installing the luminaire. Follow the safety precautions in these instructions closely and keep the instructions in a safe place.



This symbol warns you of a dangerous situation which could lead to serious injury or even death if the instructions are not observed. It also draws your attention to possible material damage and provides other important information in connection with this product.



The assembly and installation of electrical components must be carried out only by qualified personnel. Repairs must be carried out only by authorised, qualified personnel or the manufacturer. Before performing any work on the luminaire (installation, cleaning, etc.), it must be disconnected from the mains supply.



This symbol draws your attention to situations in which you could look directly into the light of the LED. This may cause an after-image effect and may result in damage to the eyes if you look at the light directly for prolonged periods.



Maintain the minimum safety distance from flammable materials: 20 cm.



This symbol warns you of hot surfaces, which could cause burns if touched.

Caution: When used for prolonged periods, the surface of the luminaire can become hot. Before performing any work on the luminaire (fitting the luminaire etc.), always switch the luminaire off and let it cool for at least 30 minutes. Only for installing in a position which is out of arm's reach.

Produktbeschreibung

LED Wand- / Deckenleuchte für den Außenbereich mit kugelförmigem Kopf und einseitigem Lichtaustritt (45°). Einsatz an Wänden zur Ausleuchtung von Stufen oder Wegen. Wahlweise mit sphärischem Glas (Sito) oder flachem Glas (Sito R) mit innenliegender Linse erhältlich, die Lichtwirkung ist beim Kauf wählbar.

Die Wand- / Deckenleuchte erreicht die Schutzklasse IP65 und ist somit staubdicht und strahlwasserfest. Version für Aufbaumontage, Anschluss an 230 V (AC) Netzspannung (VOLT light engine), dimmbar via Phasenabschnittdimmer*.

Weitere Versionen: Sito giro (Deckenleuchte), Sito verticale, Sito giù (Wandleuchte), Sito basso (Bodenleuchte), Sito palo (Pollerleuchte)

* Liste kompatibler Dimmer: www.occhio.de/dim

Product description

LED wall / ceiling luminaire for exterior with spherical head and single-sided light output. For use on walls to illuminate steps or paths. Available either with spherical glass (Sito) or flat glass (Sito R) with internal lens, the lighting effect can be decided upon purchase.

The wall / ceiling luminaire complies with protection class IP65 and is thus dust-tight and jet-proof. Version for mounting on plaster surfaces, connection to 230 V (AC) mains voltage (VOLT light engine), dimmable via trailing-edge phase-cut dimmer*.

Other versions: Sito giro (ceiling luminaire), Sito verticale, Sito giù (wall luminaire), Sito basso (floor luminaire), Sito palo (bollard)

* For a list of compatible dimmers, see www.occhio.de/dim_en

Montage
Sito lato VOLT

Mounting
Sito lato VOLT

Montage Sito lato VOLT

Mounting Sito lato VOLT

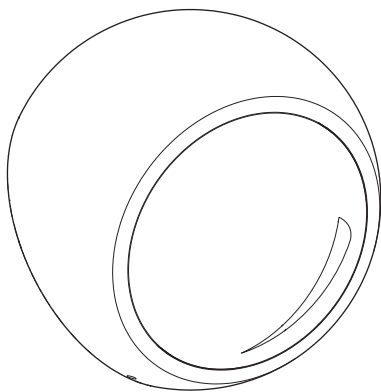

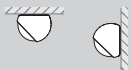

Sito lato head

Montageplatte /
mounting plate

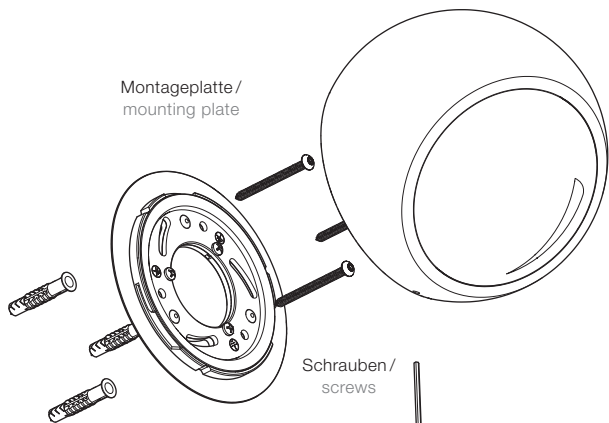

Schrauben /
screws

Dübel /
screw
anchor

Inbusschlüssel /
allen key

Verbindungsklemmen /
plug in terminals

Montage Sito lato VOLT

Mounting Sito lato VOLT

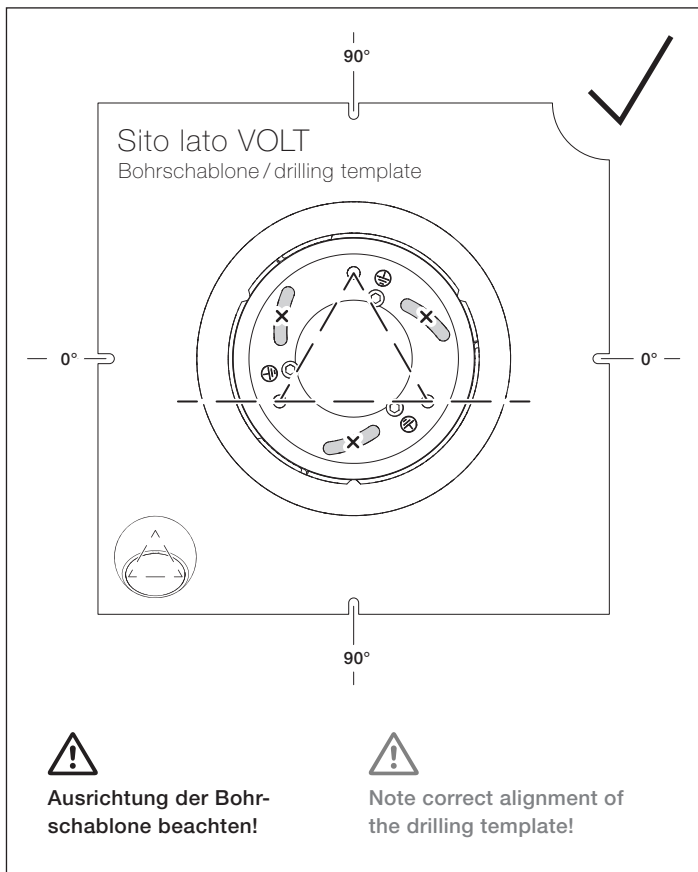

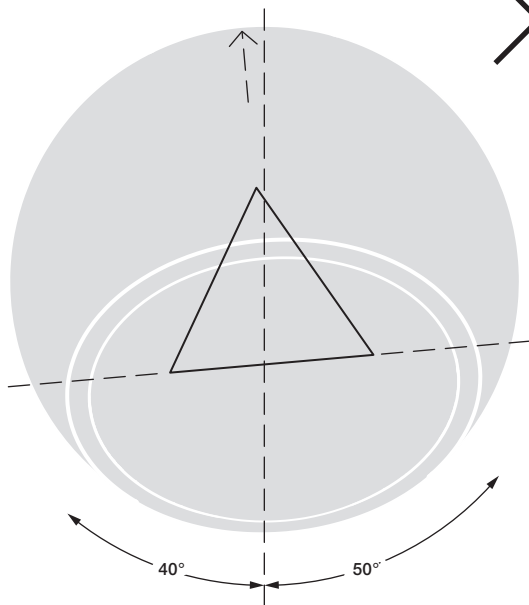
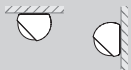

Bei falscher Montage lässt sich die Leuchte nicht zu beiden Seiten im 45° Winkel ausrichten.



If installed incorrectly, the luminaire can not be aligned on both sides at a 45° angle.

Montage Sito lato VOLT

Mounting Sito lato VOLT

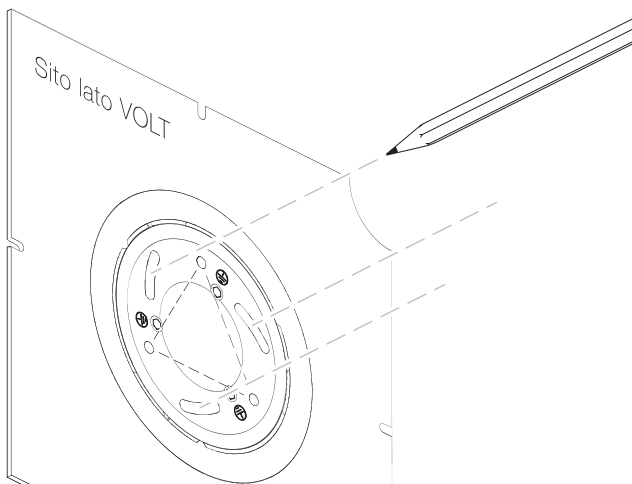

Bohrschablone benutzen!



Use drilling template!



Achtung!
**Vor der Montage alle
stromführenden Leitungen
vom Stromnetz trennen!**



Caution!
**Before mounting, disconnect
all currentcarrying lines from
the mains supply!**

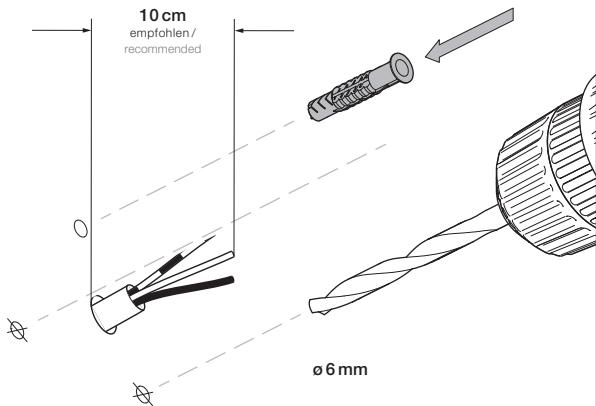
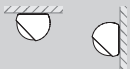

**Auf den Verlauf von
Stromleitungen
achten!**

Check the routing of the
power cables.

Montage Sito lato VOLT

Mounting Sito lato VOLT

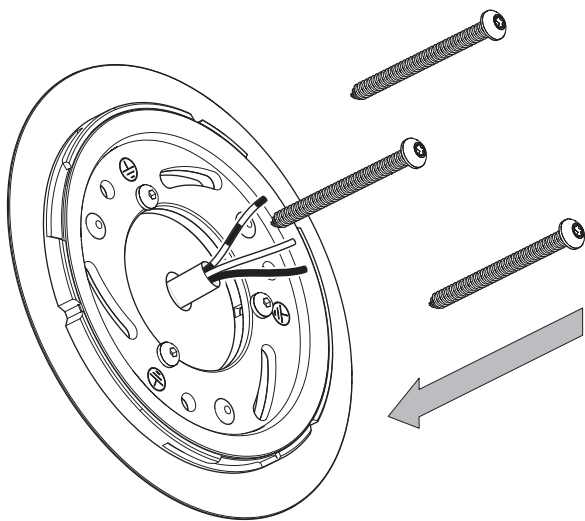

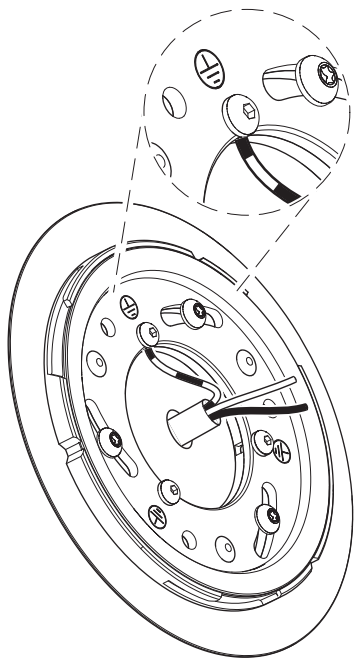
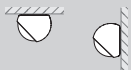

Kabel der Leuchte wie dargestellt anschließen.



Connect the luminaire's cable as shown.

Montage Sito Iato VOLT

Mounting Sito Iato VOLT

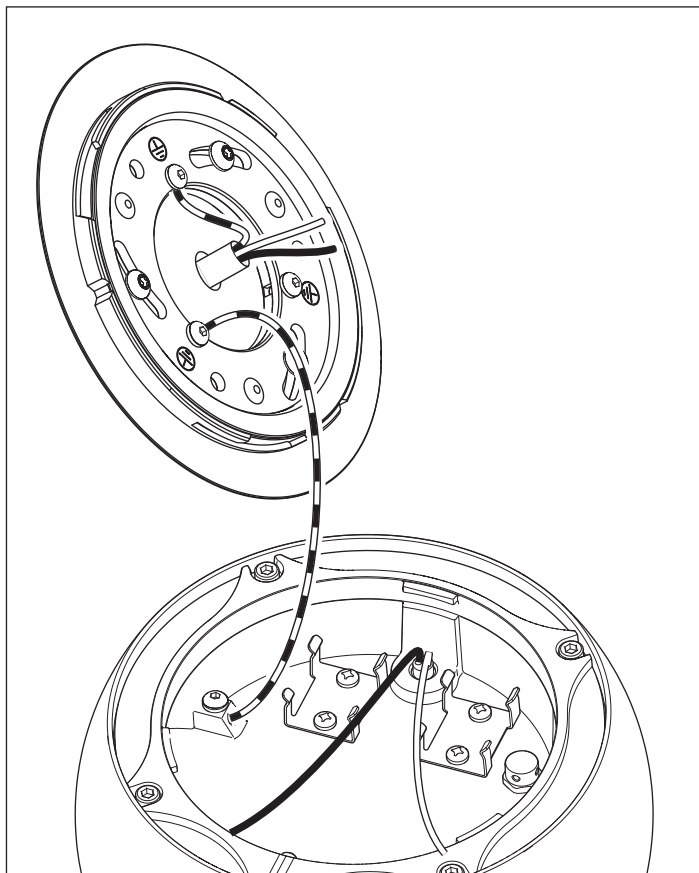

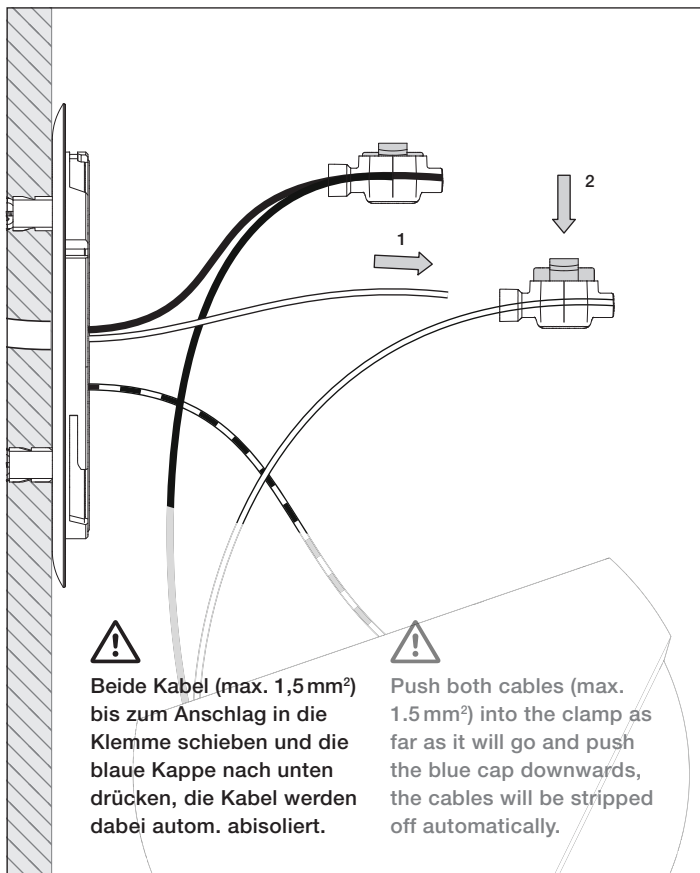
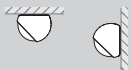

Beide Kabel (max. 1,5mm²) bis zum Anschlag in die Klemme schieben und die blaue Kappe nach unten drücken, die Kabel werden dabei autom. abisoliert.



Push both cables (max. 1.5mm²) into the clamp as far as it will go and push the blue cap downwards, the cables will be stripped off automatically.

Montage Sito lato VOLT

Mounting Sito lato VOLT

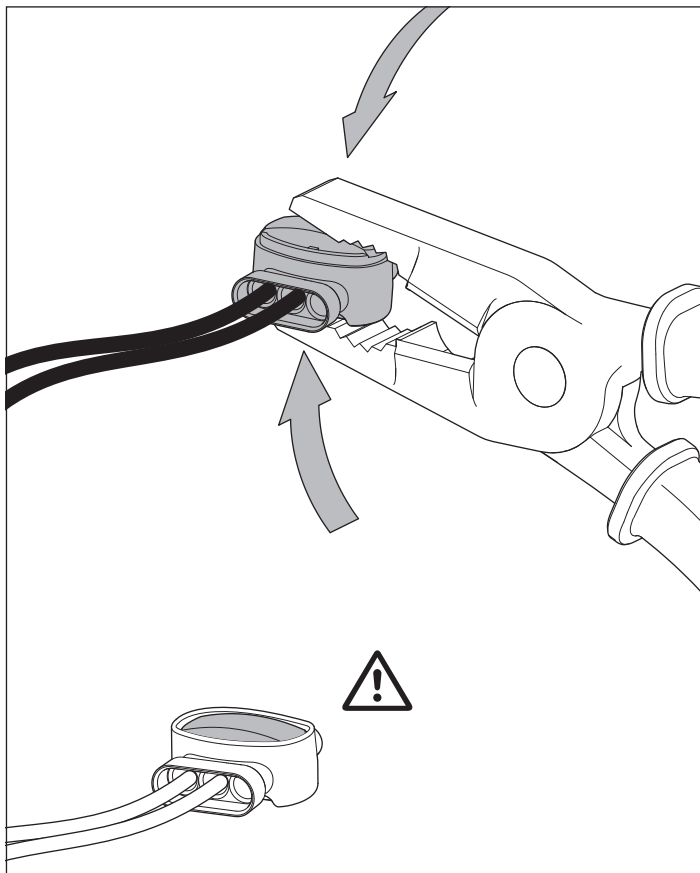

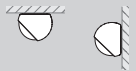

Klemmen in die Halterung setzen.

Place clamps in the holder.

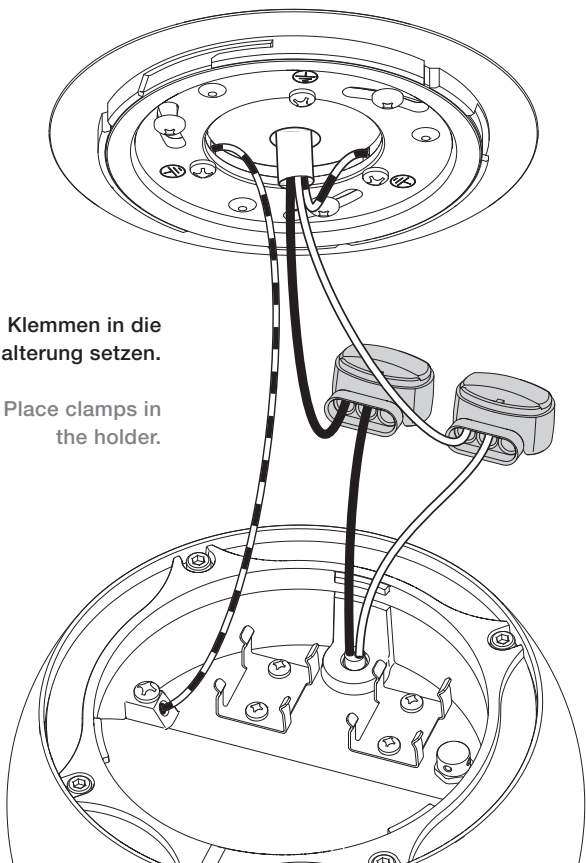

Montage Sito Iato VOLT

Mounting Sito Iato VOLT

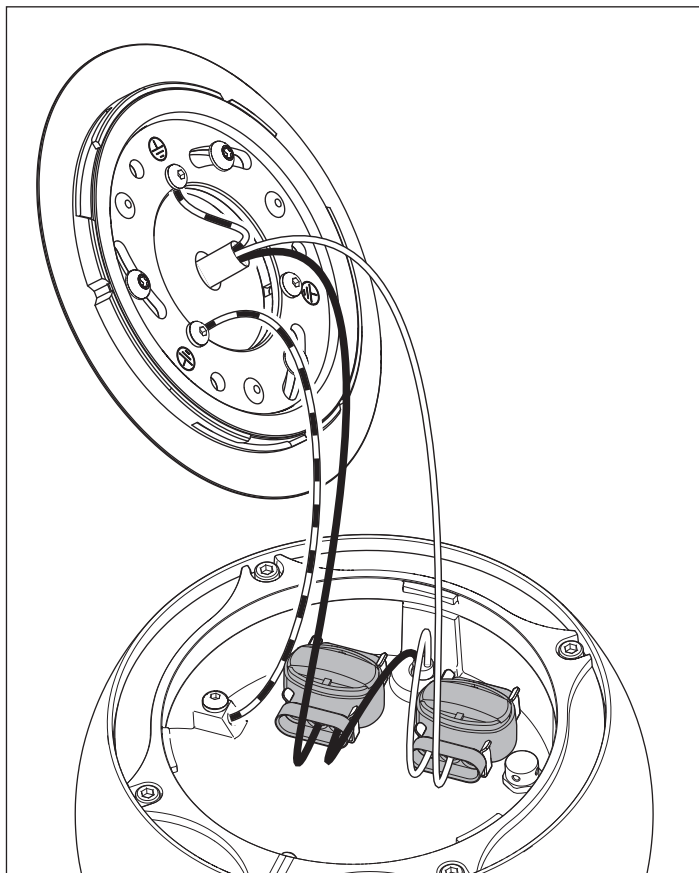

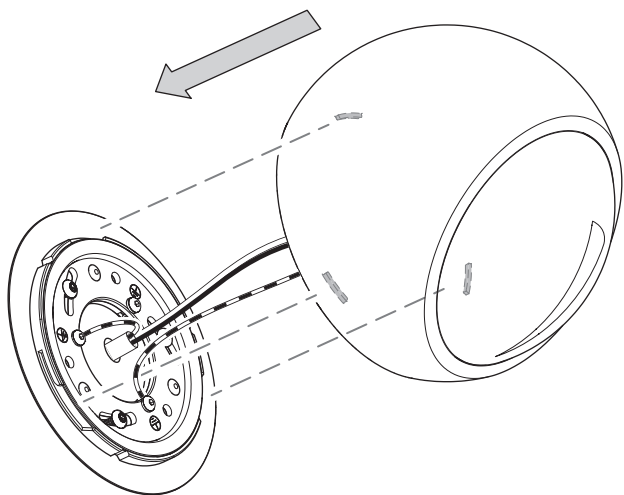
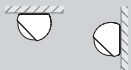

Keine Kabel bei der Befestigung einklemmen!



Do not pinch any cables during mounting!

Montage Sito lato VOLT

Mounting Sito lato VOLT

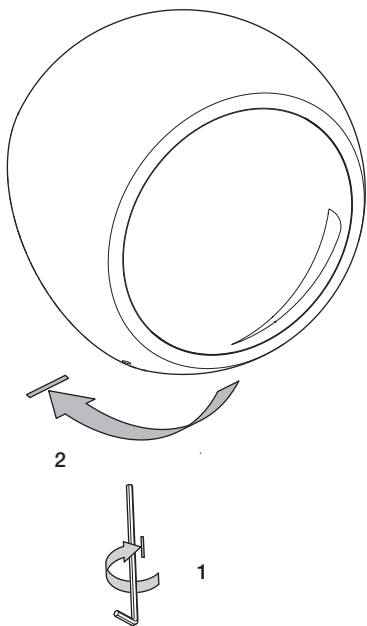

Die Leuchte bis zum Anschlag drehen und mit der Madenschraube fixieren.

Turn the luminaire until stop and lock it with the grub screw.

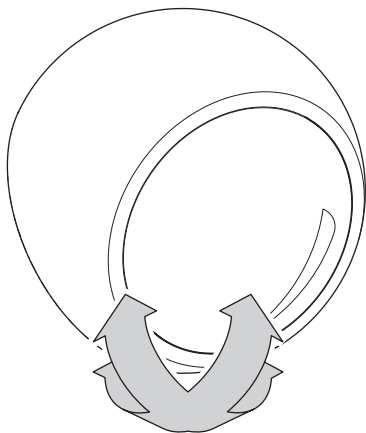

**Festen Halt der Leuchte
überprüfen!**

**Check that the luminaire is
held in place firmly.**

Montage Sito lato VOLT

Mounting Sito lato VOLT

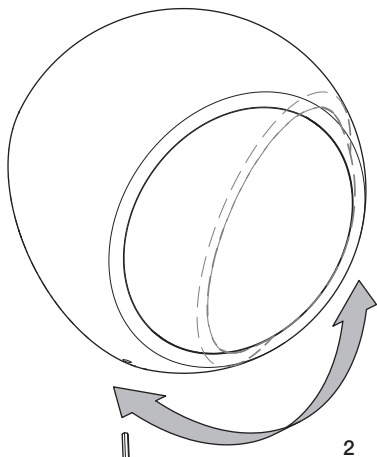

- 1 Madenschraube leicht lösen
- 2 Leuchte ausrichten
- 3 Madenschraube fixieren

1, 3



- 1 Slightly loosen the grub screw
- 2 Align the luminaire
- 3 Fix the grub screw

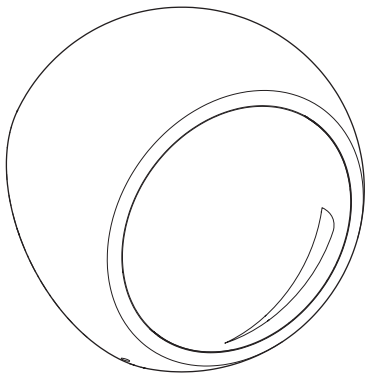
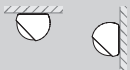

**Die Leuchte ist nun fertig
montiert.**

**The luminaire is now fully
mounted.**

Anhang

Appendix

Pflegehinweise

Care instructions

Leuchte nur in abgekühltem Zustand reinigen! Zur Reinigung der Leuchte einen milden lösungsmittelfreien Reiniger und ein weiches Tuch verwenden. Detaillierte Pflegehinweise sind unter www.occhio.de/de/company/faq zu finden.

Always allow the luminaire to cool down before cleaning! To clean the luminaire, use a gentle cleaner without solvent and a soft cloth. Detailed care instructions are available at www.occhio.de/en/company/faq.

Info & Kontakt

Information & contact





Weitere Fragen beantwortet gerne
Ihr Occhio Fachhändler

Your Occhio specialist retailer will
gladly answer any other questions

www.occhio.de
info@occhio.de

Technische Daten

Technische Daten Leuchte

Artikelbezeichnung	Sito lato VOLT
Abmessungen	ø head 130 mm, H 99 mm, Lichtaustritt 45°
Schutzklasse	1
Anschluss	230 V (AC) / 50 Hz
Dimmung	via Phasenabschrittdimmer (Liste kompatibler Dimmer: www.occhio.de/dim)
Material	Aluminium, lackiert, optisches Glas
LED-Leistung	18 W
Zulässige Betriebsbedingung	-20°C bis +40°C
Prüfzeichen	CE IP65 IK05    

Technische Daten Leuchtmittel





Leuchtmittel	VOLT light engine
Ausführung	LED-Modul
Lebensdauer	> 40.000 Std.

Entsorgung

Bei örtlicher Entsorgungsstelle entsorgen. Sito lato VOLT ist recyclebar; RoHS-konform. **Nicht in den Hausmüll geben!**

Technical data

Technical data luminaire

Product designation	Sito lato VOLT
Dimensions	ø head 130 mm, H 99 mm, light output 45°
Safety class	1
Connection	230 V (AC) / 50 Hz
Dimming	by trailing-edge phasecut dimmer (for a list of compatible dimmers, see www.occhio.de/dim_en)
Material	aluminium, painted, optical glass
LED power	18 W
Permitted operating conditions	-20°C to +40°C
Test symbols	CE IP65 IK05    

Technical data light source

Light source	VOLT light engine
Version	LED Module
Lifetime	> 40.000 h

Disposal

Dispose of at a local disposal site. Sito lato VOLT is recyclable and RoHS compliant. **Do not dispose of with the household waste!**

Occhio

www.occhio.com



010040429569669210