

Paul Neuhaus

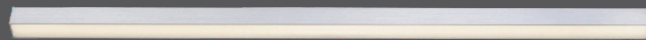

835789 - PURE-LINES

Paul Neuhaus

Paul Neuhaus GmbH

Olakenweg 36 · D-59457 Werl

☎ +49(0)2922 9721 9290

✉ Kundenservice@neuhaus-group.de

www.paul-neuhaus.de

DE

DE Dieses Produkt enthält eine Lichtquelle der Energieeffizienzklasse <E>.

GB This product contains a light source of energy efficiency class <E>.

FR Ce produit comprend une source de lumière de classe d'efficacité énergétique <E>.

ES Este producto contiene una fuente de luz de la clase de eficiencia energética <E>.

HR Ovaj proizvod sadrži izvor svjetlosti energetskeg razreda <E>.

HU Ez a termék <E> energiahatékonysági osztályba tartozó fényforrást tartalmaz.

IT Questo prodotto contiene una sorgente luminosa della classe di efficienza energetica <E>.

NL Dit product bevat een lichtbron van energie-efficiëntieklasse <E>.

LED

14,5 W

1.740 lm



18 W

1.100 lm

t

30.000 h

T_K

2.700 - 5.000 K



15.000 x



< 0,5 s



433,92 MHz
1,0 mW

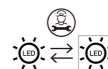

835789

230V / 50Hz~

LED 1x LED-Board 24V DC/14,5W

1x 2x 2x 2x

2x AAA, 1,5V 1x

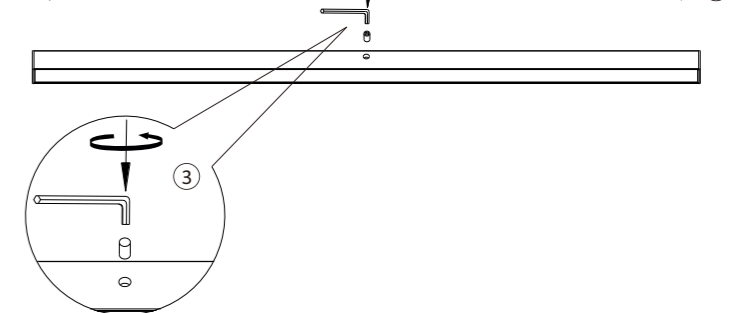
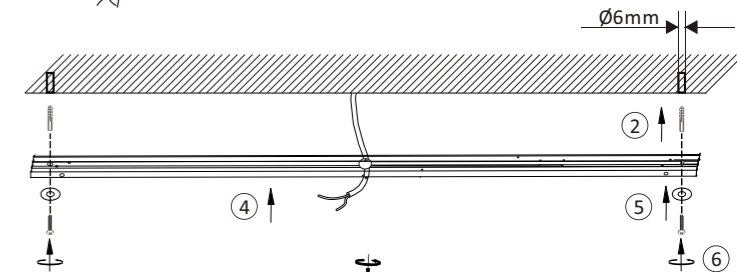
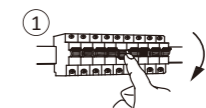

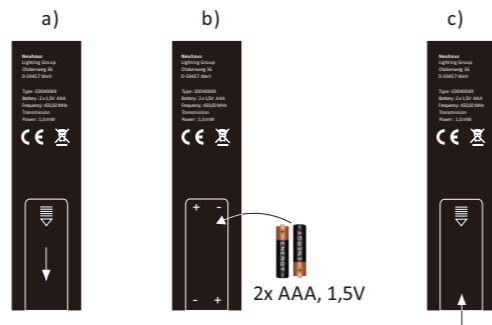
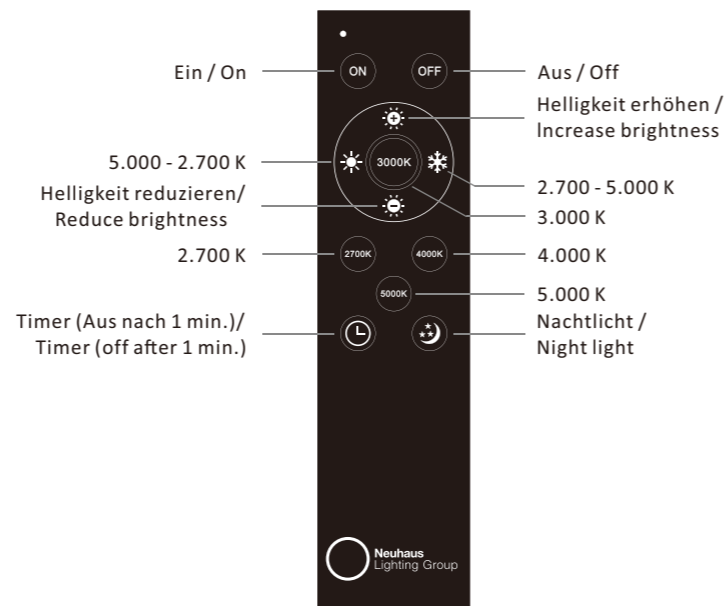
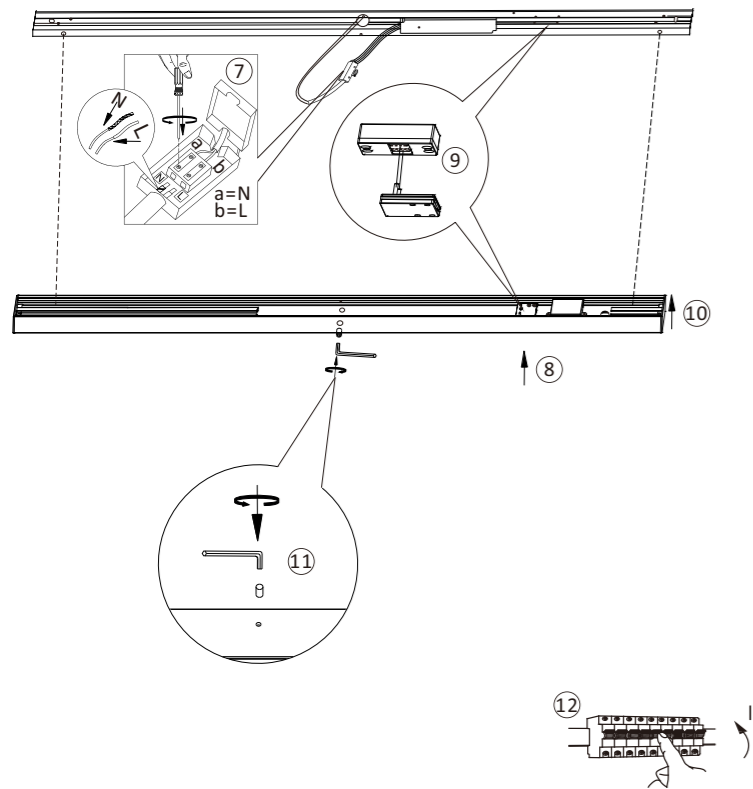

Anlernen der Fernbedienung an die Leuchte

Schalten Sie die Leuchte über den Wandschalter ein. Drücken Sie innerhalb von 5 Sekunden die ON-Taste auf der Fernbedienung. Die Leuchte ist nun angelern und kann über die Fernbedienung gesteuert werden.

!!! Eine Fernbedienung kann unbegrenzt viele Leuchten steuern. Eine Leuchte kann von einer Fernbedienung angesteuert werden !!!

Assigning the remote control to the light

Switch the light on via the wall switch. Press the ON button on remote control within 5 seconds. The light is now assigned and can be operated by the remote control.

!!! A remote control can control an unlimited number of lights. A light can be operated by one remote control !!!

Beschreibung / Description	Betriebsgröße / Operation data
Batterie / Battery	2x AAA, 1,5V
Sendefrequenz / Transmission frequency	433,92 MHz
Sendeleistung / Transmitting power	1,0 mW
Leerlaufstrom / No-load current	0,001 mA
Betriebsstrom / Operating current	max.15 mA
Reichweite der Fernbedienung / Range of the remote control	6-8 m

